

# USTAR II™

Limb Salvage System



# Table of Contents

---

<b>System Description</b> .....	11	<b>Total Femoral Replacement</b> .....	49
		Total Femoral Assembly .....	50
<b>Distal Femoral Replacement</b> .....	1	A. Measure the Length of the Entire Femur .....	51
Distal Femoral Assembly .....	2	B. Trialing .....	52
A. Pre-operative Planning .....	3	C. Implant Assembly .....	54
B. Femoral Osteotomy .....	5		
C. Canal Preparation .....	6	<b>Proximal Tibial Replacement</b> .....	57
D. Establish Tibial Platform .....	10	Proximal Tibial Assembly .....	58
E. Finish Tibial Preparation .....	13	A. Pre-operative Planning .....	59
F. Trialing .....	17	B. Tibial Osteotomy .....	61
G. Implant Assembly .....	23	C. Canal Preparation .....	62
H. Implantation .....	26	D. Distal Femoral Resection .....	66
		E. Femoral Canal Preparation .....	68
<b>Proximal Femoral Replacement</b> .....	31	F. Femoral Sizing and Placement .....	70
Proximal Femoral Assembly .....	32	G. Femoral Box Preparation .....	75
A. Pre-operative Planning .....	33	H. Trialing .....	80
B. Femoral Osteotomy .....	35	I. Implant Assembly .....	86
C. Canal Preparation .....	36	J. Implantation .....	90
D. Trialing .....	40		
E. Implant Assembly .....	43	<b>Appendix</b>	
F. Implantation .....	46	I. Taper Disassembly .....	95
		II. Distal Femoral Replacement <b>XS</b> .....	97
		III. Proximal Tibial Replacement <b>XS</b> .....	103
		<b>Order Information</b> .....	113

# System Description

The USTAR II System is designed for extensive reconstruction of the hip and knee joint. Components have been designed based on 20 years experience with the previous USTAR system. The information contained in this surgical technique guide outlines the intended use of the instruments and implants. Surgeons select and utilize the system based on the individual needs of each patient.

The modularity of USTAR II system is designed to allow flexibility to address a variety of difficult surgical situations including the following:

- Proximal Femoral Replacement
- Distal Femoral Replacement
- Proximal Tibial Replacement
- Total Femoral Replacement
- Hinge Knee



## INDICATIONS

1. Metastatic tumor (i.e. osteosarcoma, chondrosarcoma, giant cell tumor or osteoma) where massive resection and transplantation are needed.
2. Severe hip or knee joint damage resulting from trauma where massive resection and transplantation are needed.
3. Non-inflammatory degenerative joint disease such as avascular necrosis, osteoarthritis, or traumatic arthritis.
4. Revision of previously failed total joint arthroplasty, osteotomy, or arthrodesis.
5. Joint instability resulting from excessive bone resection.

*Please refer to the package inserts for important product information, including, but not limited to contraindications, warnings, precautions, and adverse effects.*

# Distal Femoral Replacement



## Distal Femoral Assembly

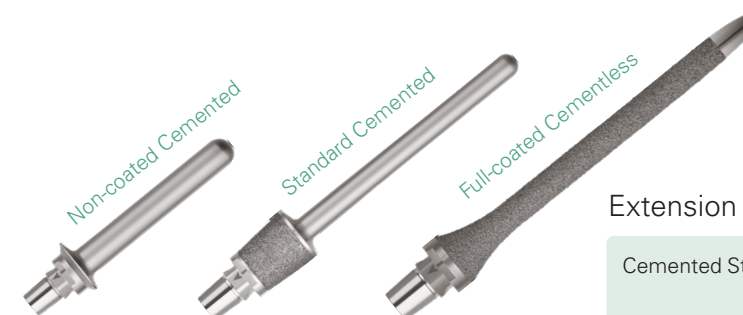

### Extension Stem

Cemented Stem Length : Straight 100 / 125 mm  
 Curved 125 / 150 mm  
 Diameter : 9 / 11 / 13 / 15 / 17 mm  
 Full-coated Stem Length : 150 / 200 mm  
 Diameter : 11 / 13 / 15 / 17 mm

### Segment

Length : 25 / 30 to 220 mm in 10 mm Increments



### Distal Femoral Component

Length : 55 mm  
 Left and Right



### Tibial Insert

Size : S and M  
 7 Thickness : 12 / 14 / 17 / 20 / 23 / 26 / 30 mm



### Tibial Baseplate

6 Baseplate Sizes (#1 to #6)

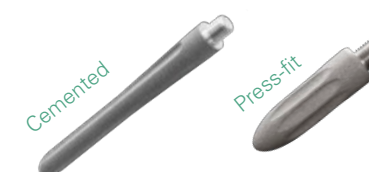

### Tibial Stem

Cemented Stem Diameter : 9 mm  
 Cemented Stem Length : 20 / 45 / 70 / 95 mm  
 Press-fit Stem Diameter : 12.5 mm / 14 mm  
 Press-fit Stem Length : 45 / 70 / 95 / 120 mm



# A. Pre-operative Planning

Plan the proper combination of components with the **Resection Template**.

Note the length for Standard Distal femoral components is 55 mm.

For the Standard Cemented Stem, use the medial side of the template with the etched marking 'C'. This includes the extra 31 mm titanium plasma spray coating section on the Standard Cemented Stem that adds to the extra-medullary total length. The rest of the cutouts indicate the additional segment length options.

For the Non-Coated Cemented Stem or Full-Coated Cementless stem, use the lateral side of the template with the etched marking 'NC'. This includes the extra 5 mm on the Non-Coated Cemented stem or the Full-Coated Cementless stem that add to the extra-medullary total length. The rest of the cutouts indicate the additional segment length options.

Please note the final combination of components may be different at the actual time of surgery.

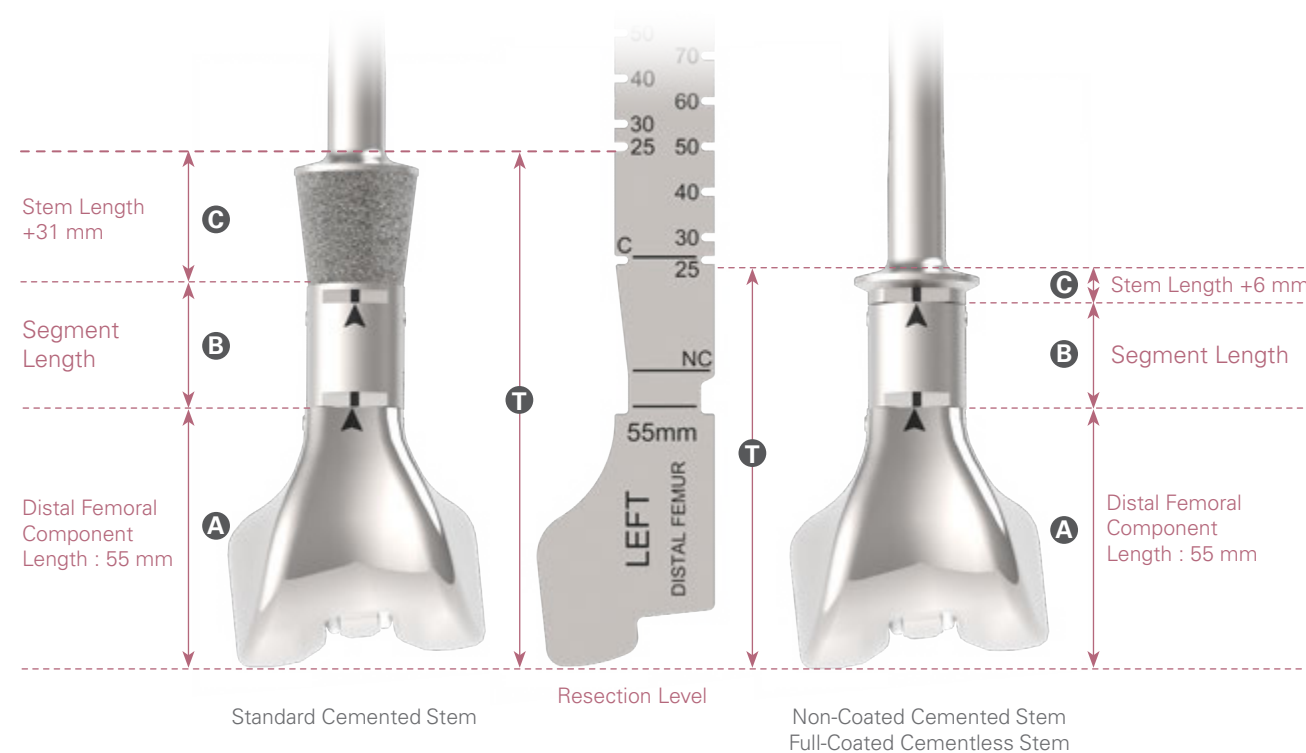
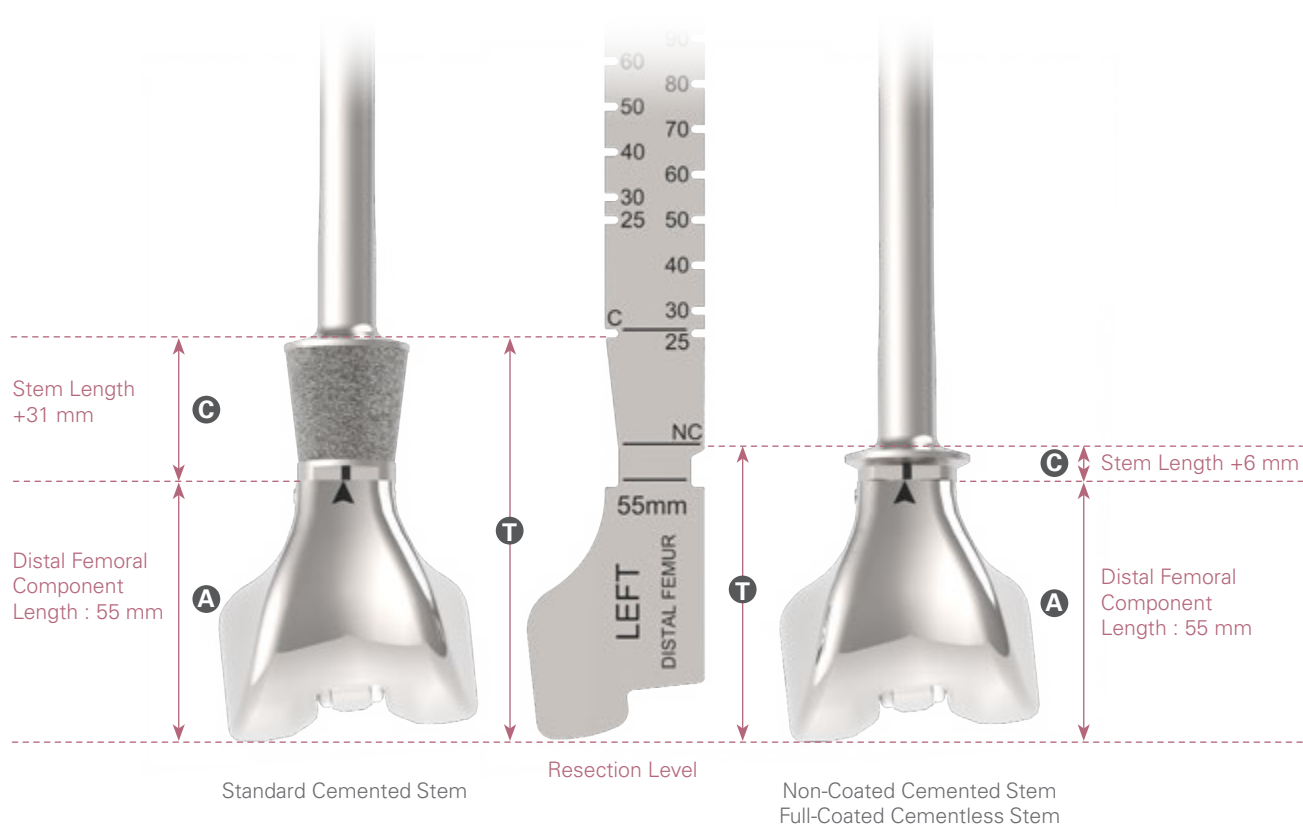

Reference Chart for Standard Cemented Stem			
T Resection Length	A Component	B Segment	C Stem
86 mm	Distal Femoral Component Length		Standard Cemented Stem
111 mm		25 mm	
116 mm		30 mm	
126 mm		40 mm	
136 mm		50 mm	
146 mm		60 mm	
156 mm		70 mm	
166 mm		80 mm	
176 mm		90 mm	
186 mm		100 mm	
196 mm	110 mm	+31 mm	
206 mm	120 mm		
216 mm	130 mm		
226 mm	140 mm		
236 mm	150 mm		
246 mm	160 mm		
256 mm	170 mm		
266 mm	180 mm		
276 mm	190 mm		
286 mm	200 mm		
296 mm	210 mm		
306 mm	220 mm		

Reference Chart for Non-Coated Cemented Stem and Full-Coated Cementless Stem			
T Resection Length	A Component	B Segment	C Stem
61 mm	Distal Femoral Component Length		Non-Coated Cemented Stem
86 mm		25 mm	
91 mm		30 mm	
101 mm		40 mm	
111 mm		50 mm	
121 mm		60 mm	
131 mm		70 mm	
141 mm		80 mm	
151 mm		90 mm	
161 mm		100 mm	
171 mm	110 mm	Full-Coated Cementless Stem	
181 mm	120 mm		
191 mm	130 mm		
201 mm	140 mm		
211 mm	150 mm		
221 mm	160 mm		
231 mm	170 mm		
241 mm	180 mm		
251 mm	190 mm		
261 mm	200 mm		
271 mm	210 mm		
281 mm	220 mm		

Note: the length of XS distal femoral component is 50 mm, 5 mm less than standard component. The XS articular surface fit only with XS Insert and XS Baseplate. Please refer to the appendix II for XS Tibial preparation.

## B. Femoral Osteotomy

Measure the appropriate resection length by aligning the **Resection Template** to the level of the most distal medial condyle and mark a resection reference line. Create an anterior reference mark (L) to align with the indicator on the stem.

Perform the femoral osteotomy at the reference resection line perpendicular to the shaft.

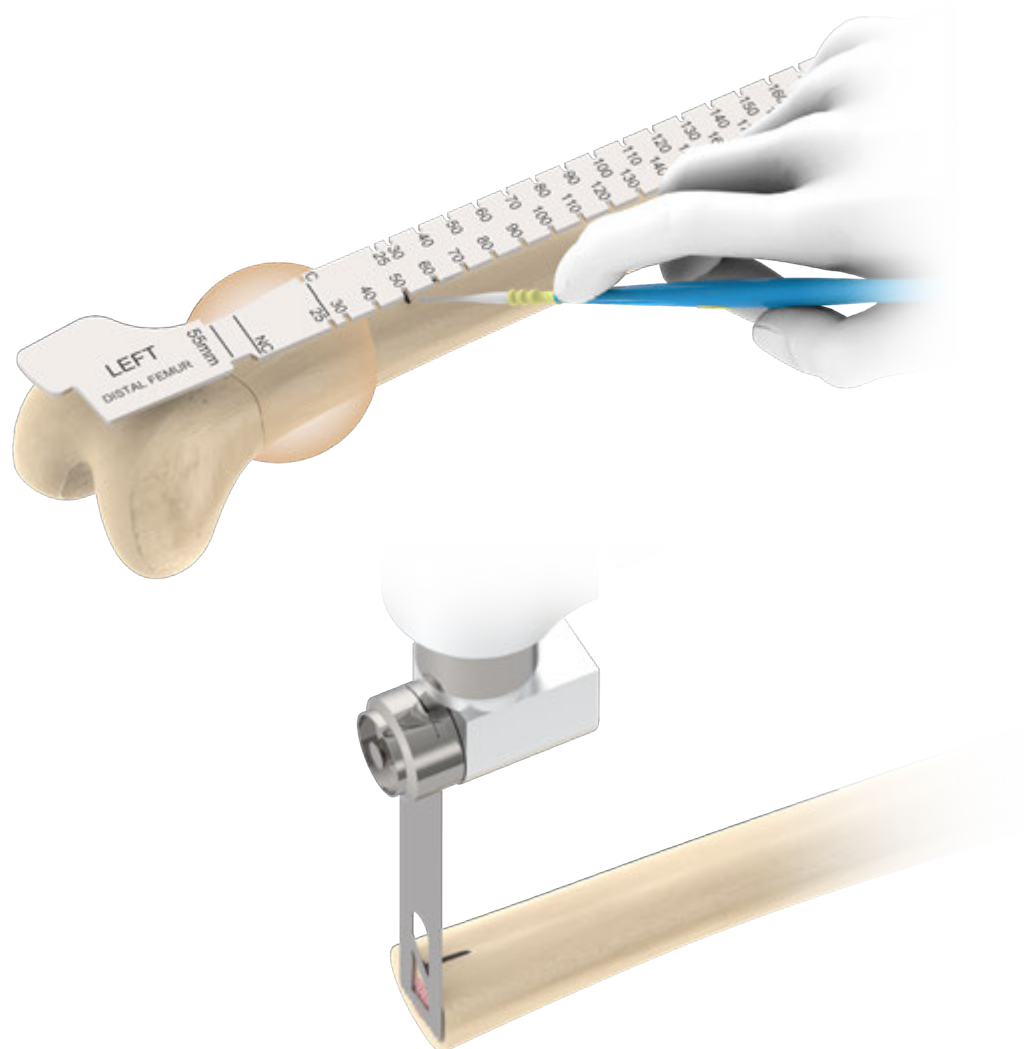

Instruments



Resection Template

## C. Canal Preparation

For the standard cemented stem and non-coated cemented stem, progressively ream the canal with the **Straight Stem Reamer** in 1 mm increments until the appropriate diameter and depth is achieved as indicated on the etched 'C' markings on the reamers. A stem diameter of 1~2 mm less than the final reamer is preferred for an adequate cement mantle.

For the full-coated cementless stem, progressively ream the canal with the **Straight Stem Reamers** that have 1 mm increments until the appropriate diameter and depth is achieved as indicated on the etched 'P' markings on the reamers. A stem diameter equal to the final reamer is recommended for an optimal press-fit. Optional reamer diameter of 11.5 / 13.5 / 15.5 / 17.5 mm are also included for the finer press-fit adjustment.

For a curved stem, there may need to be an additional difference in diameter between the final reamer and selected stem.



**Example of reaming for standard cemented stem or non-coated cemented stem.**

The etched marking C125 indicates an appropriate depth for a 125 mm cemented stem.

**Example of reaming for full coated cementless stem.**

The etched marking P150 indicates an appropriate depth for a 150 mm full coated cementless stem.

Instruments



Straight Stem Reamer  
Diameter 8~21 mm

# C.Canal Preparation

Stem Options Reference Chart

	Straight Stem	Curved Stem
Standard Cemented Stem	9 mm diameter x 100 mm Length	9 mm diameter x 125 mm Length
	11 mm diameter x 100 mm Length	11 mm diameter x 125 mm Length
	13 mm diameter x 100 mm Length	13 mm diameter x 125 mm Length
	15 mm diameter x 100 mm Length	15 mm diameter x 125 mm Length
	17 mm diameter x 100 mm Length	17 mm diameter x 125 mm Length
	9 mm diameter x 125 mm Length	9 mm diameter x 150 mm Length
	11 mm diameter x 125 mm Length	11 mm diameter x 150 mm Length
	13 mm diameter x 125 mm Length	13 mm diameter x 150 mm Length
	15 mm diameter x 125 mm Length	15 mm diameter x 150 mm Length
	17 mm diameter x 125 mm Length	17 mm diameter x 150 mm Length
Non-coated Cemented Stem	9 mm diameter x 100 mm Length	9 mm diameter x 125 mm Length
	11 mm diameter x 100 mm Length	11 mm diameter x 125 mm Length
	13 mm diameter x 100 mm Length	13 mm diameter x 125 mm Length
	15 mm diameter x 100 mm Length	15 mm diameter x 125 mm Length
	17 mm diameter x 100 mm Length	17 mm diameter x 125 mm Length
	9 mm diameter x 125 mm Length	9 mm diameter x 150 mm Length
	11 mm diameter x 125 mm Length	11 mm diameter x 150 mm Length
	13 mm diameter x 125 mm Length	13 mm diameter x 150 mm Length
Full Coated Cementless Stem	N/A	N/A
	11 mm diameter x 150 mm Length	11 mm diameter x 150 mm Length
	13 mm diameter x 150 mm Length	13 mm diameter x 150 mm Length
	15 mm diameter x 150 mm Length	15 mm diameter x 150 mm Length
	17 mm diameter x 150 mm Length	17 mm diameter x 150 mm Length
	N/A	N/A
	11 mm diameter x 200 mm Length	11 mm diameter x 200 mm Length
	13 mm diameter x 200 mm Length	13 mm diameter x 200 mm Length
	15 mm diameter x 200 mm Length	15 mm diameter x 200 mm Length
	17 mm diameter x 200 mm Length	17 mm diameter x 200 mm Length



# C.Canal Preparation

For the standard cemented stem and non-coated cemented stem, connect the **Cemented Stem Barrel Reamer** to the appropriate **Reamer Guide Rod** and advance into the canal to prepare the resected distal femur.

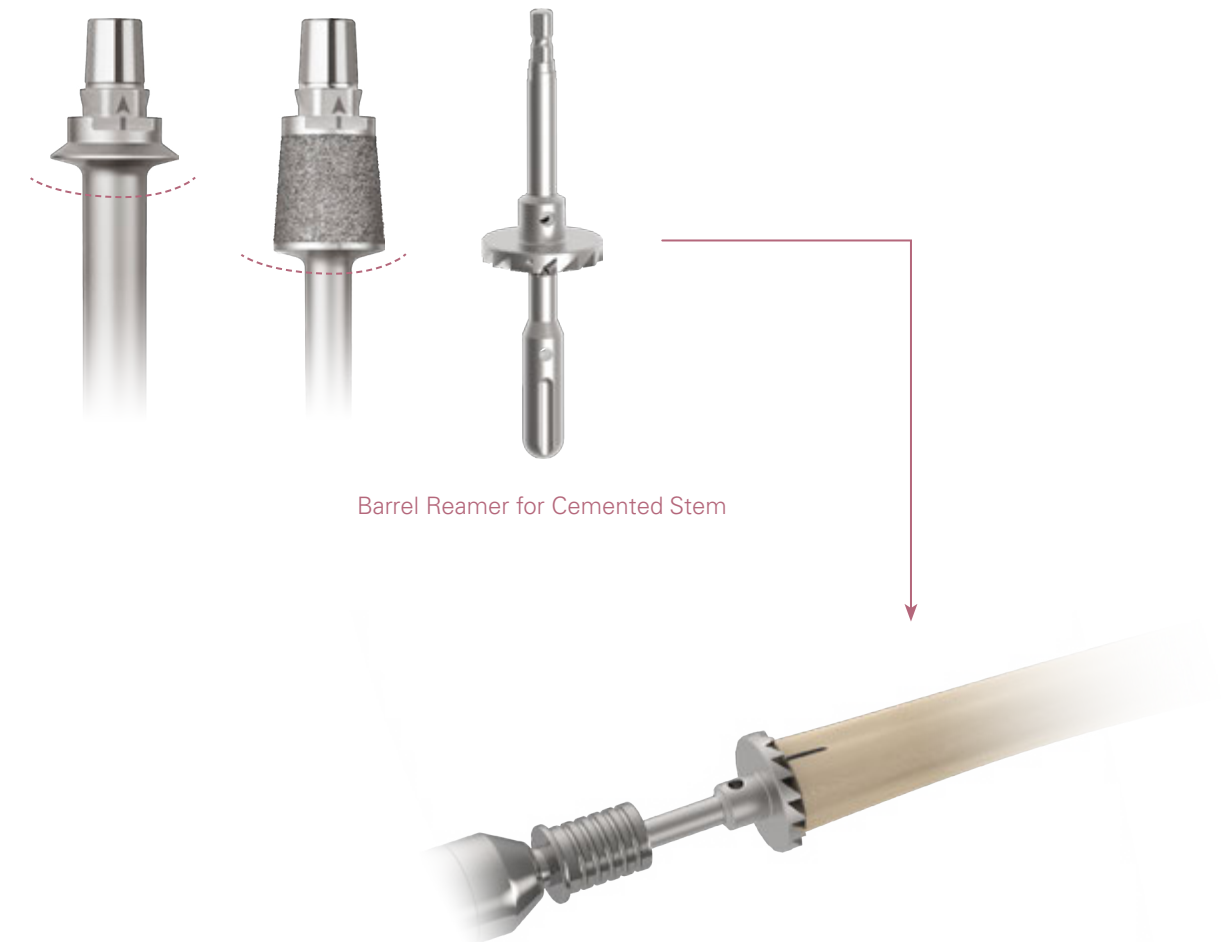

Barrel Reamer for Cemented Stem

Instruments

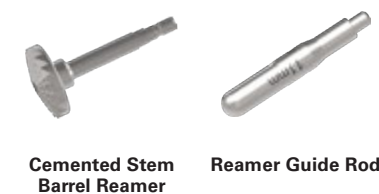

Cemented Stem Barrel Reamer Reamer Guide Rod

# C. Canal Preparation

For the cementless stem, connect the **Cementless Stem Barrel Reamer** to the appropriate **Reamer Guide Rod** and advance into the canal to prepare the resected distal femur.

Ream to the distal cut-out marking on the barrel reamer. If less than 3 mm of cortical bone around the reamer is observed, stop reaming. The planned implant construct will be 8 mm longer than the original measured plan. The cementless stem will sit above the bone (proud) by 14 mm (8 mm coated and 6 mm non-coated area on the proximal end of stem). The length of the implant construct may be adjusted by selecting a shorter segment or making other adjustment.

If there is 3 mm or more of cortical bone around the barrel reamer after the initial reaming step, continue reaming to the proximal cut-out marking on the barrel reamer. The planned implant construct will match the original measured plan. The cementless stem will sit above the bone (proud) by 6mm (6mm non-coated area on the proximal end of the stem). This will be the non-coated area on the proximal end of the stem.

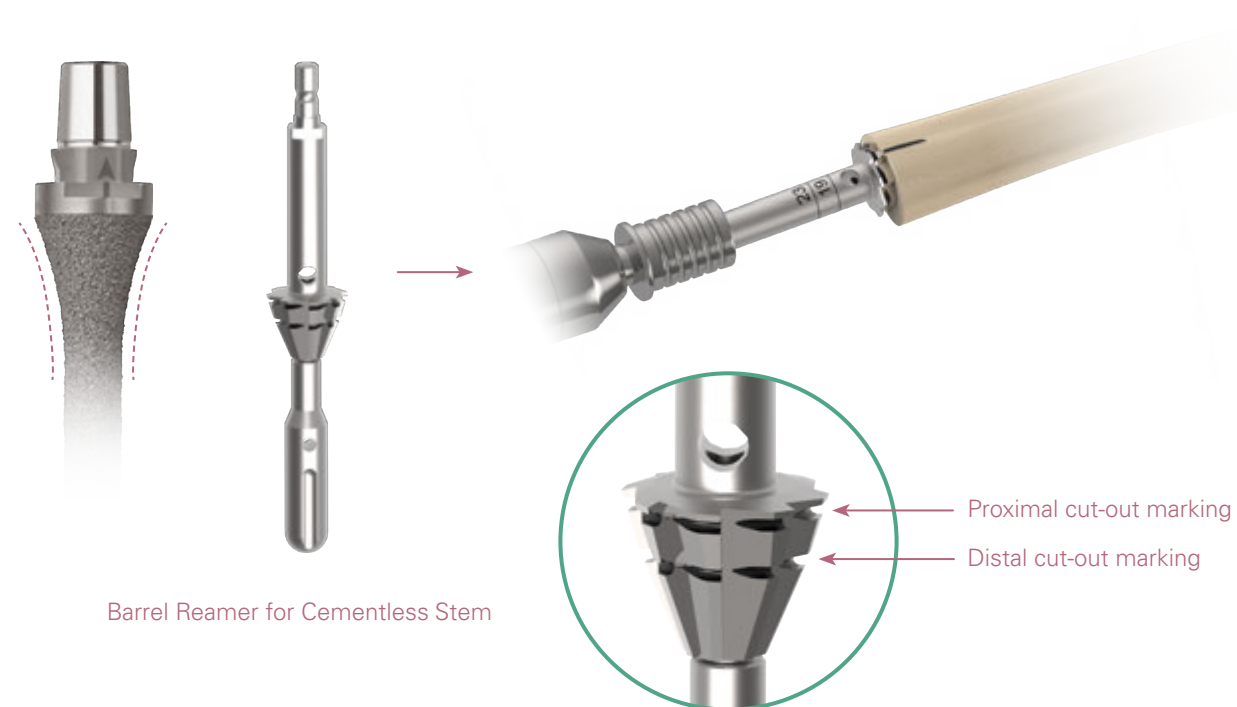

Barrel Reamer for Cementless Stem

Instruments



Cementless Stem Barrel Reamer Reamer Guide Rod

# D. Establish Tibial Platform

Set the knee in flexion to fully expose the tibial plateau. Use the **Step Drill** to find the canal. The entry location shall be approximately 10 mm posterior to the origin of anterior cruciate ligament.

Using the **T-Handle**, advance the **Tibial IM Rod** into the canal. Then remove the **T-Handle**.

Assemble the **Tibial IM Alignment Guide** and the **Tibial Resection Guide** onto the **Tibial IM Rod**.

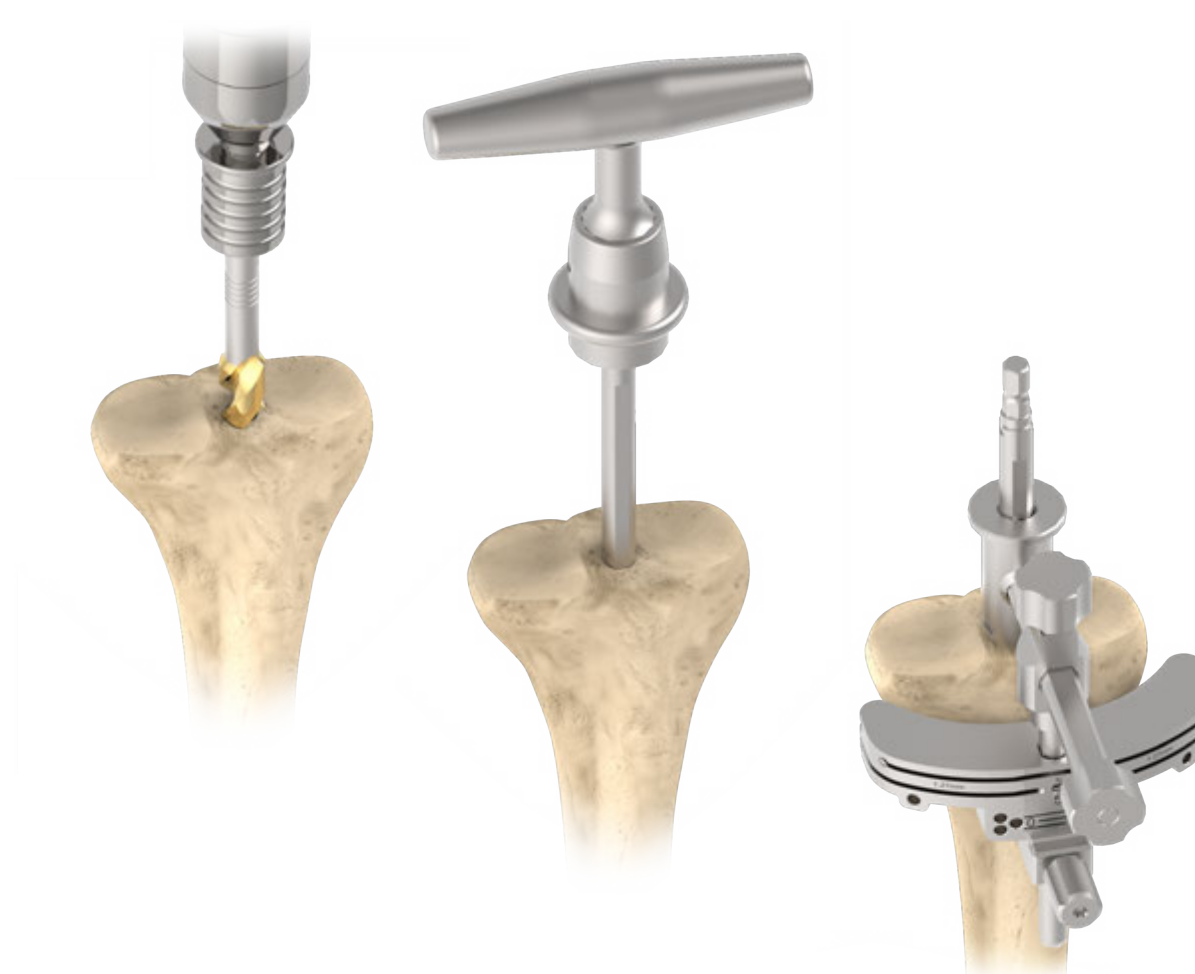

Instruments



Step Drill T-Handle Tibial IM Rod Tibial Resection Guide Tibial IM Alignment Guide



# D. Establish Tibial Platform

Insert the 12 mm **Tibial Stylus** into the first slot which was labeled "N" on the **Tibial Resection Guide**. Position the tip of the **Tibial Stylus** on the appropriate reference point of the tibial plateau to evaluate the standard 12 mm tibial bone resection from the joint line. The **Resection Check Blade** may be inserted into the first slot labeled "N" on the **Tibial Resection Guide** to confirm positioning.

If a smaller resection is desired, an optional 2 mm / 9 mm **Tibial Stylus** is available.



Instruments

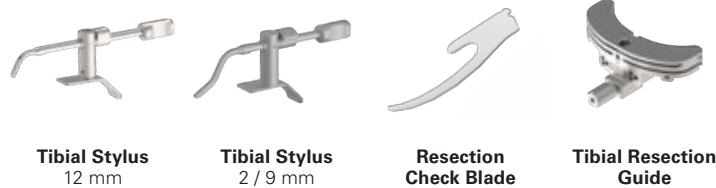

Tibial Stylus  
12 mm

Tibial Stylus  
2 / 9 mm

Resection  
Check Blade

Tibial Resection  
Guide

# D. Establish Tibial Platform

Secure the **Tibial Resection Guide** with two **Round Pins** through the holes labeled '0'.

Remove the intramedullary assembly, leaving the resection guide in place. If needed, additional **Threaded Pins** may be used to further secure the resection guide.

Perform the proximal tibial resection using a standard .050" (1.27 mm) saw blade inserted through the first slot labeled "N".

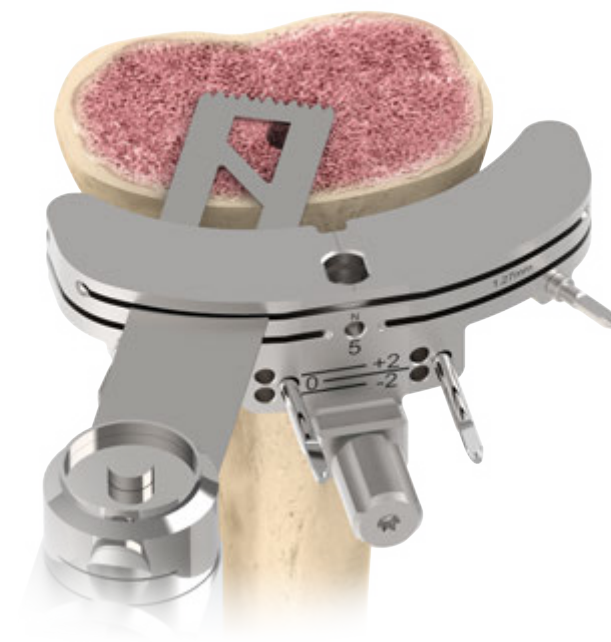

Instruments



Round Pin

Threaded Pin

Tibial Resection  
Guide

# E. Finish Tibial Preparation

Select the **Tibial Sizing Template** that provides the desired tibial coverage and attach it to the **Tibial Sizing Template Handle**. Place onto the resected tibial surface, then insert the **Tibial IM Rod** into the tibial canal. Slide the **Tibial Neutral Bushing** over the the **Tibial IM Rod and** onto the **Tibial Sizing Template**.

Attach the **Alignment Rod** to the **Tibial Sizing Template Handle** to help confirm optimal position.

Align the **Tibial Sizing Template** with the desired rotational position on the resected tibial surface, maintaining orientation with the the **Tibial IM Rod/Tibial Neutral Bushing** assembly. Secure with two **Round Pins**.

Remove the **Tibial Neutral Bushing, Tibial IM Rod** and the **Alignment Rod**.

Attach the **Tibial Punch Guide** onto the sizing template.

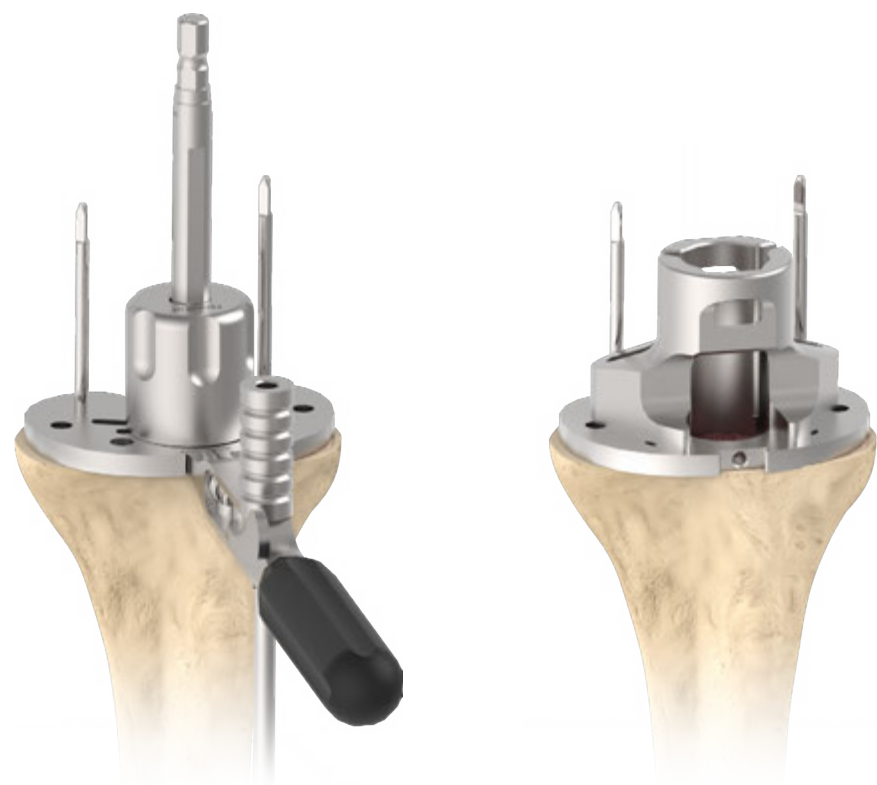

Instruments

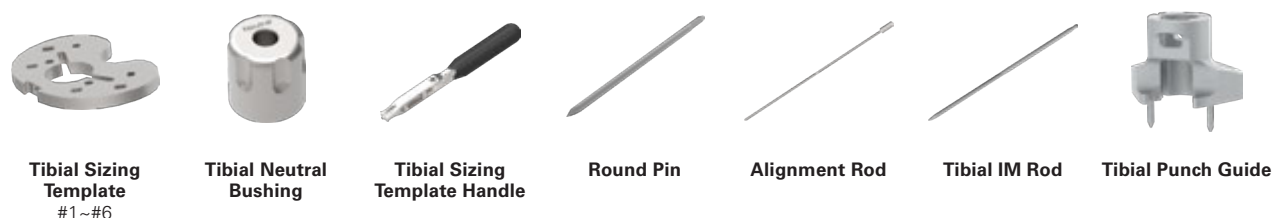

# E. Finish Tibial Preparation

Insert the **Tibial Stem Drill** into the tibial canal. Place the **Tibial Stem Drill Sleeve** over the **Tibial Stem Drill**.

Different reamer diameters are available to obtain the desired stability. There are different reaming depths engraved on each reamer. Align the depth marking to the **Tibial Stem Drill Sleeve** in order to reach the appropriate depth of the desired stem length. Refer to the etched "C" depth marking for the 9 mm diameter cemented stem; and the etched "P" depth marking for the 12.5 mm and 14 mm diameter press-fit stem.

A 12.5 mm diameter reamer is recommended for an optimal press-fit of a 12.5 mm diameter press-fit tibial stem; while a 14 mm diameter reamer is recommended for an optimal press-fit of a 14 mm diameter press-fit tibial stem. If the desired stability is unable to achieve with the use of 12.5 mm and 14 mm reamers, the use of cemented stem is suggested.

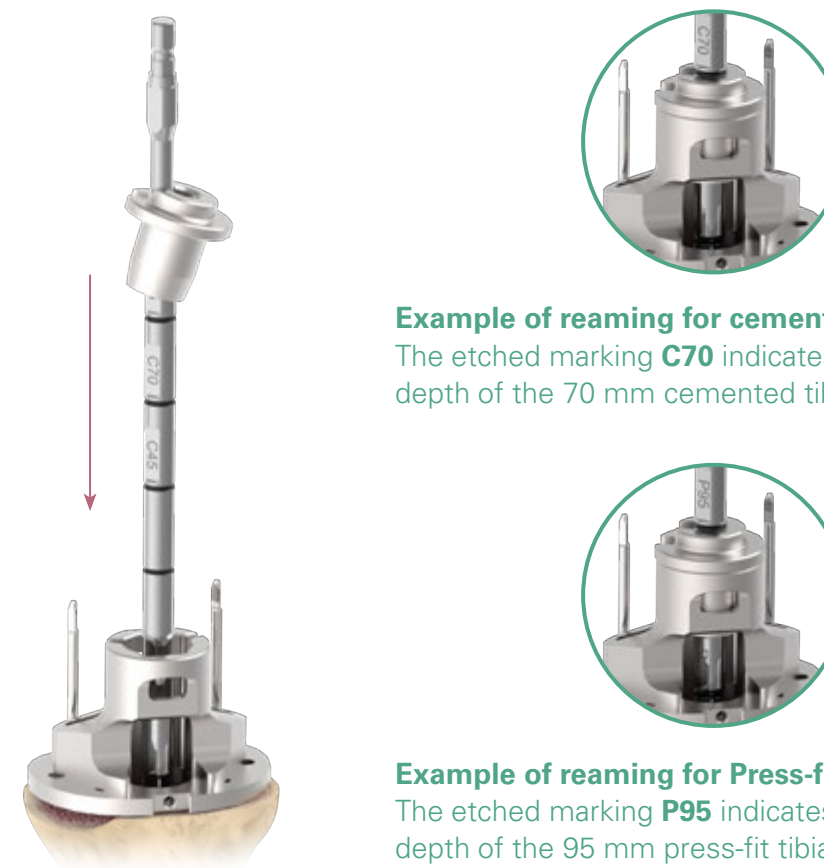

**Example of reaming for cemented tibial stem.**  
The etched marking **C70** indicates the appropriate depth of the 70 mm cemented tibial stem.

**Example of reaming for Press-fit tibial stem.**  
The etched marking **P95** indicates the appropriate depth of the 95 mm press-fit tibial stem.

Instruments



# E. Finish Tibial Preparation

Select the correct **Tibial Boss Drill** for the selected tibial implant construct and advance through the **Tibial Punch Guide** until fully engaged.

For the tibial baseplate with no stem or a 20 mm stem, use the silver **Tibial Boss Drill - Short**.

For the tibial baseplate with a 45 mm stem or longer, use the gold **Tibial Boss Drill - Long**.

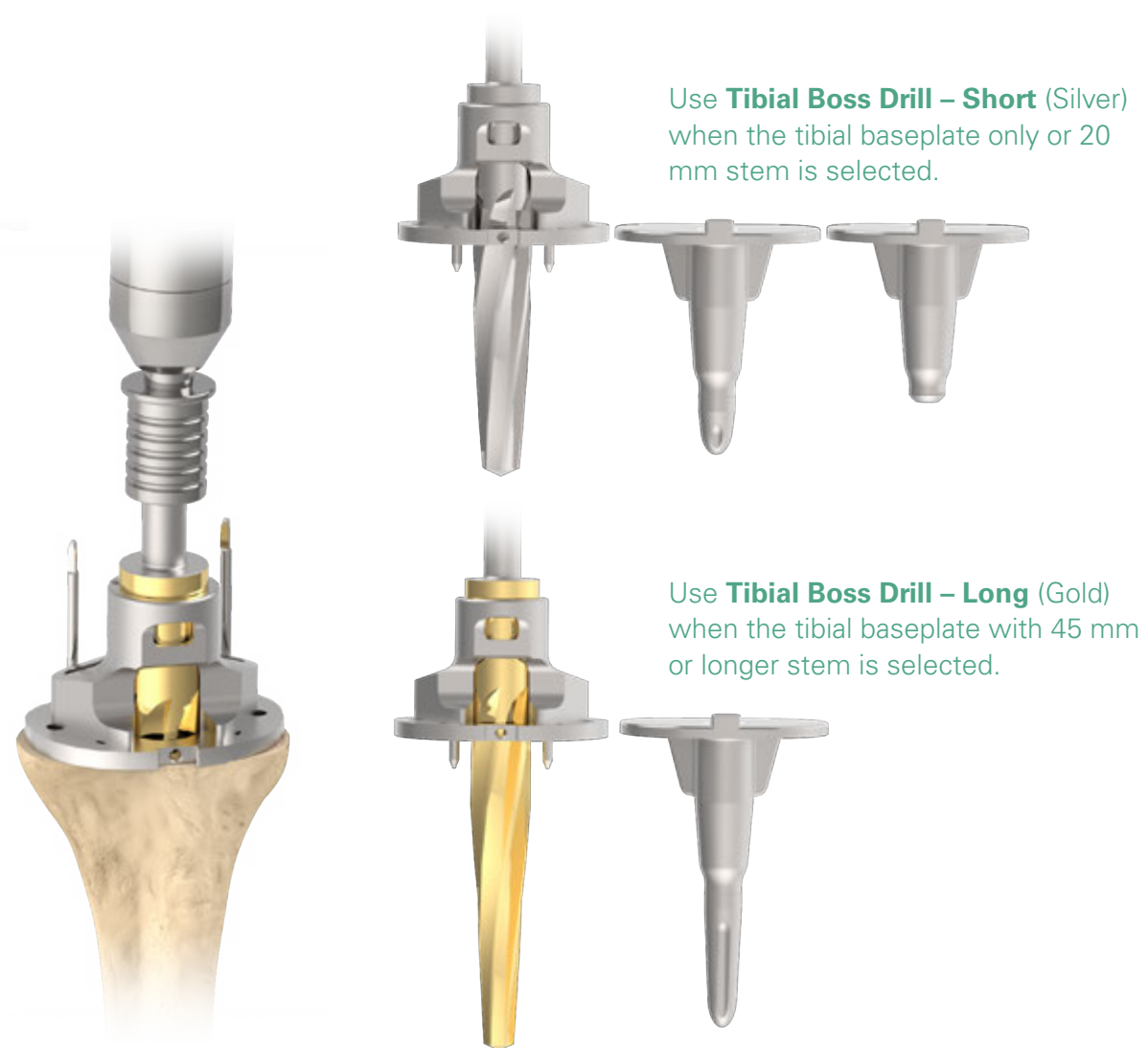

Instruments



# E. Finish Tibial Preparation

Choose the **Tibial Punch** that corresponds to selected **Tibial Sizing Template** and attach it to the **Tibial Punch Handle**. The corresponding sizes are marked on the side of the **Tibial Punch**.

Advance the **Tibial Punch** through the **Tibial Punch Guide** until fully engaged.

Disengage the Tibial Punch assemblies with the **Slotted Hammer** and remove the **Tibial Sizing Template**.



Instruments





# F.Trialing

If a tibial stem is selected, thread the corresponding **Tibial Stem Trial** into the bottom of the selected **Tibial Baseplate Trial**.

Attach the **Tibial Baseplate Trial Driver** to the **Modular Handle**.

Insert the tip of the **Tibial Baseplate Trial Driver** into the center hole of the tibial trial assembly and turn the driver ¼ turn in the clockwise direction to lock the driver into the tibial trial assembly.

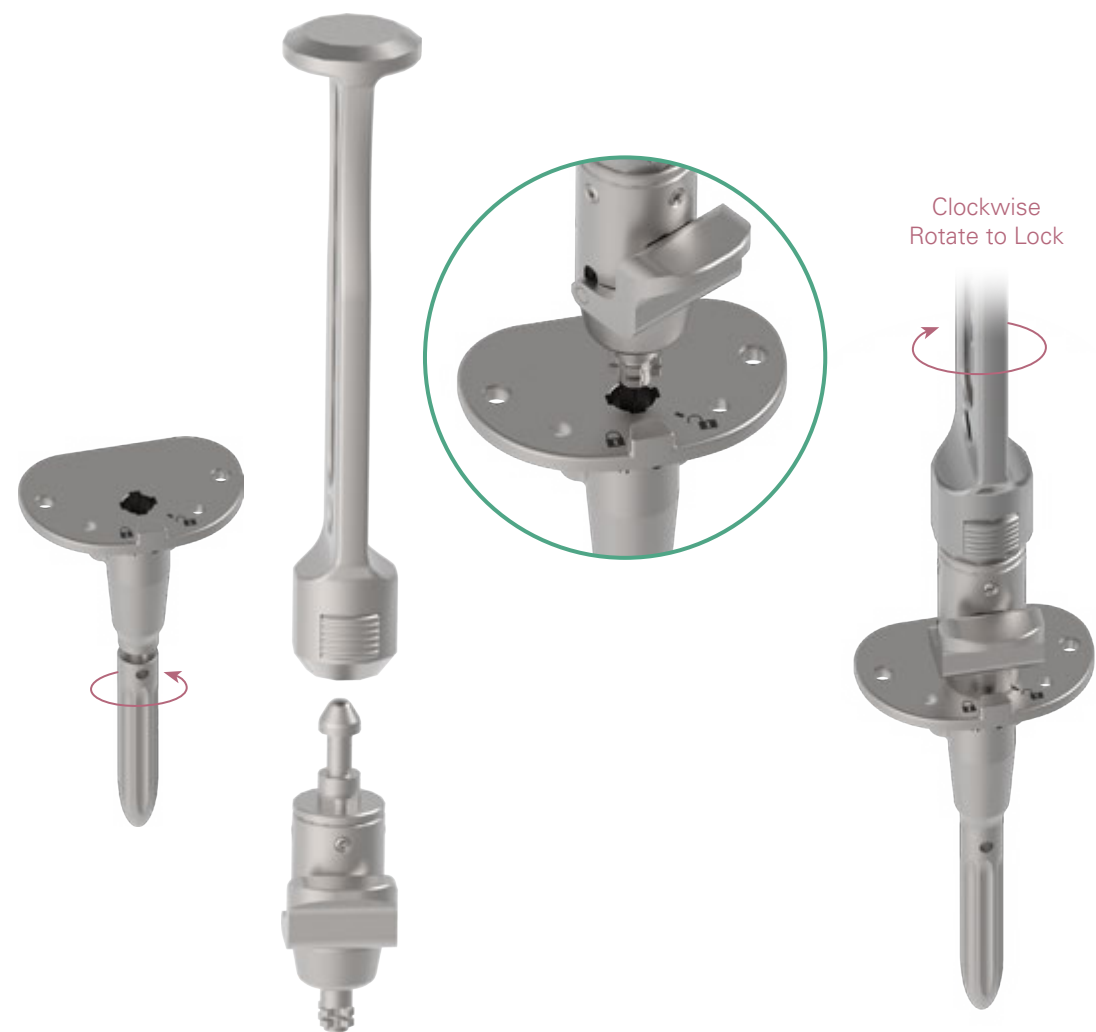

Instruments



Tibial Baseplate Trial Tibial Stem Trial Modular Handle Tibial Baseplate Trial Driver

# F.Trialing

Choose the **Stem Trial Body** and **Stem Trial Adapter** that corresponds to selected cemented or cementless stem size.

Attach the **Stem Trial Body** into the **Stem Trial Adapter** (see image part 1 and 2, the anterior indicators shall align together).

Insert the **Screwdriver Adapter T30** into the top of the **Stem Trial Adapter** and secure with the **Driver Handle** (see image part 3).

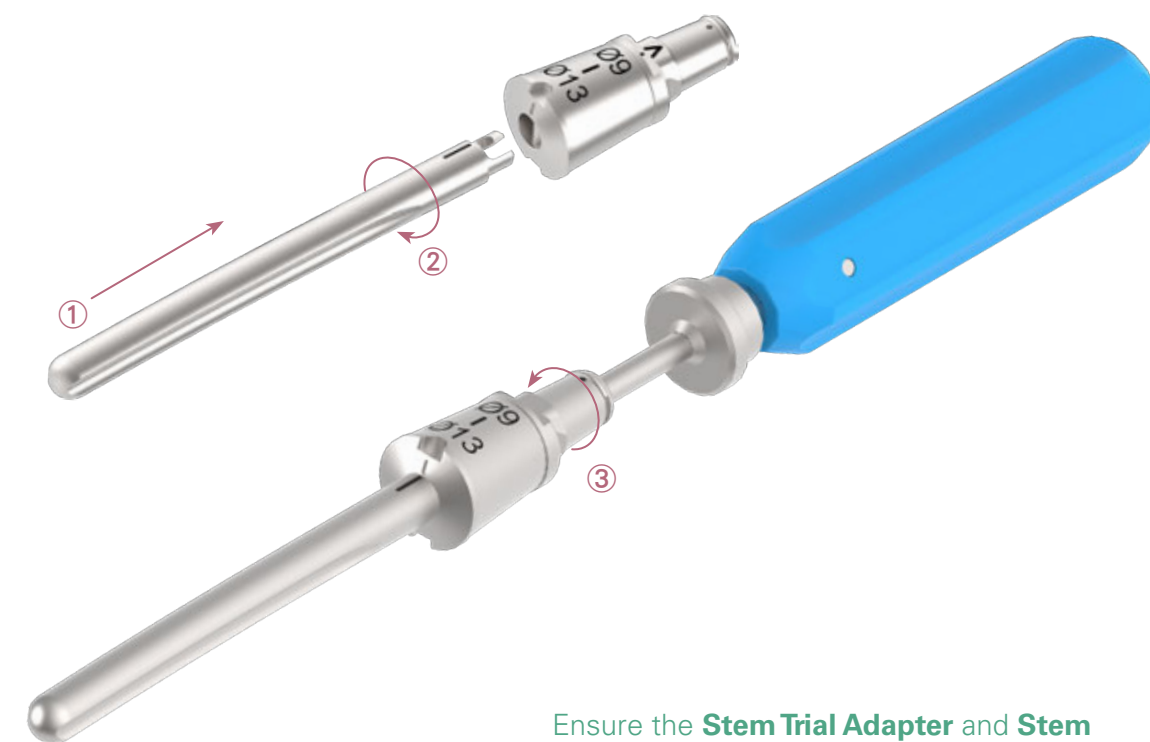

Ensure the **Stem Trial Adapter** and **Stem Trial Body** are fully attached and locked into position prior to trialing.

Instruments



Cemented Stem Trial Body Diameter 9~17 mm  
 Cemented Stem Trial Adapter Diameter 9~13 mm  
 Cementless Stem Trial Body Diameter 11~17 mm  
 Cementless Stem Trial Adapter Diameter 11~17 mm  
 Driver Handle  
 Screwdriver Adapter, T30

# F. Trialing

Identify the correct length **Segment Trial** to restore femoral length using the chart below. During trialing, multiple trial segments may be combined to represent the ideal monolithic component assembly length.

Attach the selected **Segment Trial(s)** to the selected **Distal Femoral Trial**. Attach the **Distal Femoral Trial/Segment Trial** assembly to the **Stem Trial Adapter/Stem Trial Body** assembly.

**Segment Trial Reference Chart**

Segment (mm)	Segment Trial (mm)
25	25
30	30
40	40
50	50
60	60
70	70
80	30 + 50
90	40 + 50
100	40 + 60
110	110
120	50 + 70
130	60 + 70
140	30 + 110
150	150
160	50 + 110
170	60 + 110
180	70 + 110
190	40 + 150
200	50 + 150
210	60 + 150
220	70 + 150

Combining shorter Segment Trials to mimic longer length of segments



Always align the anterior marking when assembling the trial components or the implant assemblies

Instruments



**Segment Trial**  
25-150 mm      **Distal Femoral Trial**  
Left/Right

# F. Trialing

Place the femoral trial assembly onto the prepared femoral surface. Align the anterior reference mark on the bone with the anterior marking on the trial assemblies.

Place the tibial trial assembly onto the resected tibial surface and impact until fully seated into position. Retract the release lever to remove the **Tibial Baseplate Trial Driver**.



Instruments



**Modular Handle**      **Tibial Baseplate Trial Driver**

# F.Trialing

Identify the required **Tibial Insert Trial** and **Yoke Adapter** based on the selected **Tibial Baseplate Trial** size: The #1 to #3 tibial baseplate size corresponds with the size S Yoke Adapter, the #4 to #6 tibial baseplate size corresponds with the size M Yoke Adapter.

Insert the selected **Yoke Adapter** onto the the **Tibial Baseplate Trial**.

Connect the **Yoke Adapter** and the **Distal Femoral Trial**.

Attach the selected **Tibial Insert Trial** to the **Tibial Insert Trial Handle** and connect to the **Yoke Adapter** on the tibial assembly.

Evaluate joint stability using the selected trial components. Switch to different **Tibial Insert Trial** thicknesses as needed to obtain optimal stability.

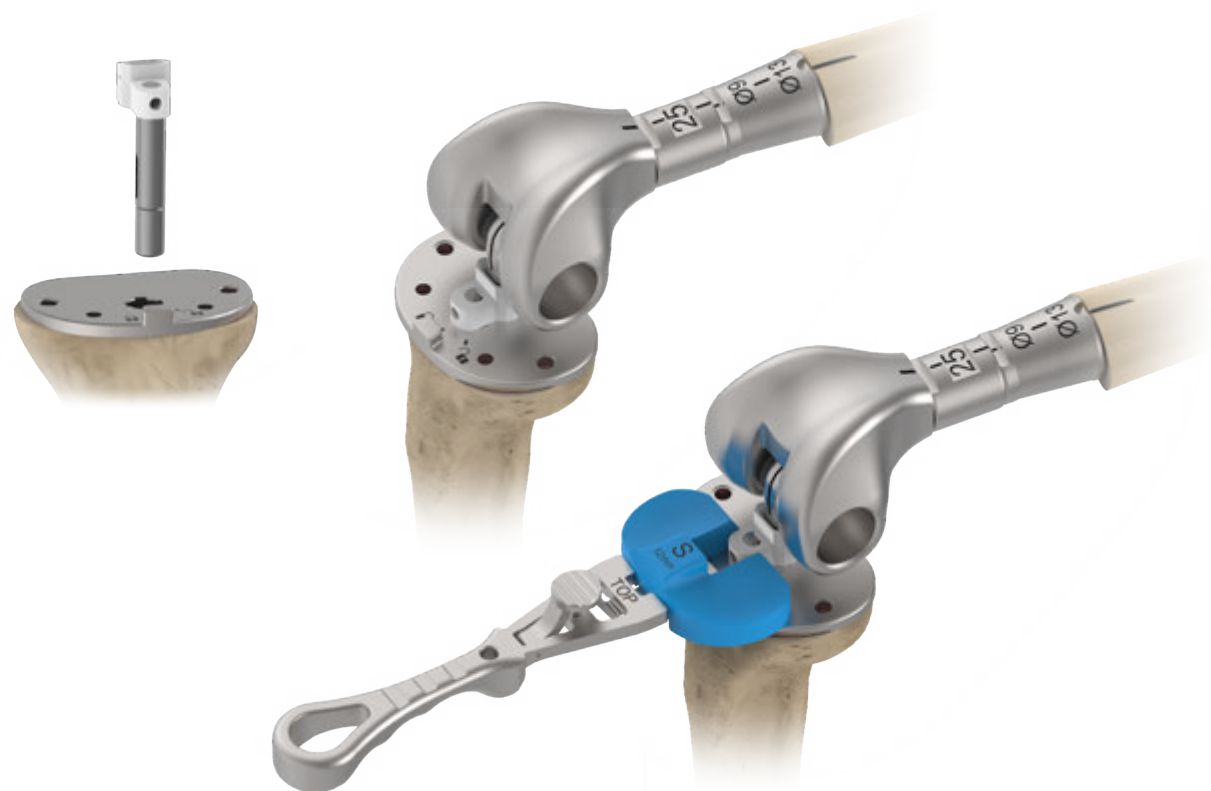

Instruments



Distal Femoral Trial Left/Right

Yoke Adapter S, M

Cemented Tibial Baseplate Trial

Tibial Insert Trial

Tibial Insert Trial Handle

# F.Trialing (Removal)

Position the **Taper Separator** at the junction between each trial component and separate by levering the trials.

If it is difficult to remove the stem trial assembly manually, remove the stem trial by connecting the **Stem Trial Remover** to the end of the trunnion. Utilize the **Slotted Hammer** remove the stem trial if needed.

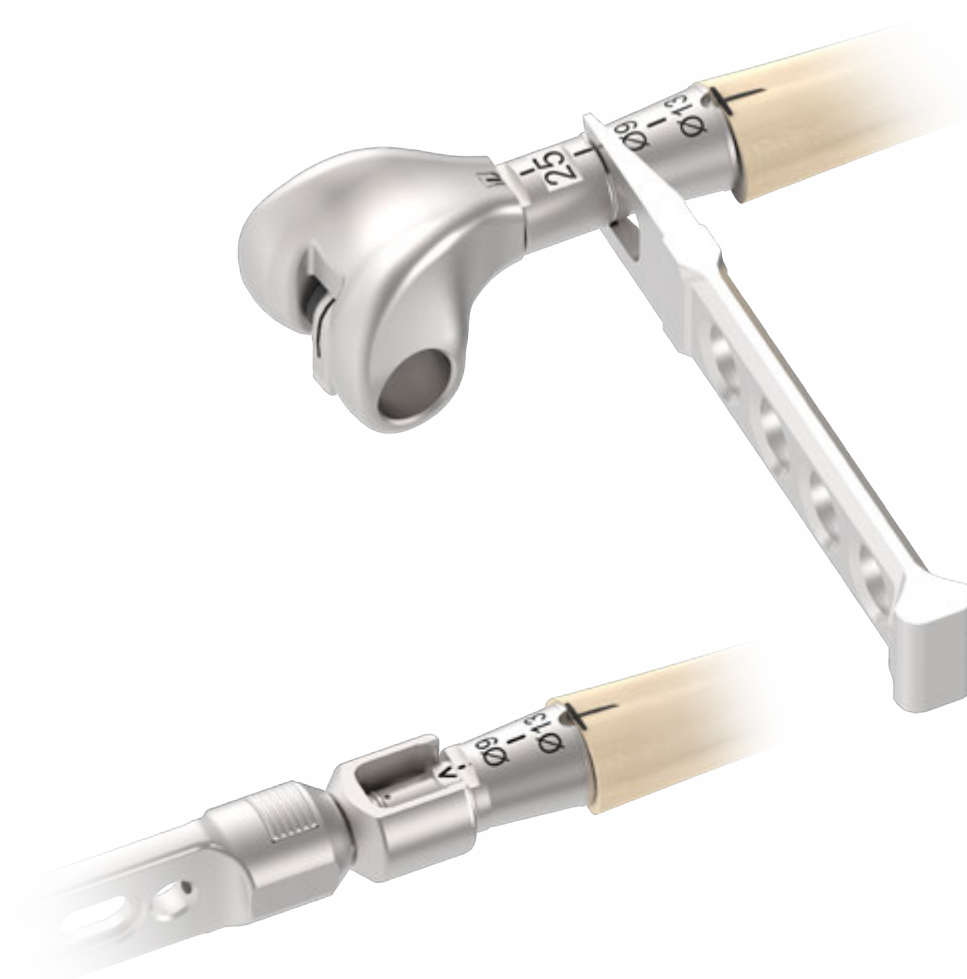

Instruments



Taper Separator

Modular Handle

Stem Trial Remover

Slotted Hammer

# G. Implant Assembly

Assemble the implants starting with distal femoral component and the segment (if selected), then the selected stem.

Place the selected distal femoral component onto the **Distal Femur Impactor Base**. Verify the medial and lateral set screws are not obstructing the taper recess, loosening the set screws if needed.

Connect the distal femoral component with the correct segment component by aligning the anterior mark and tapping the prosthesis with the **Stem Impactor** in position.

Confirm the medial and lateral set screws on the segment is not obstructing the taper recess. Connect the selected stem component to the distal femoral component/segment assembly by aligning the anterior mark and tapping the prosthesis with the **Stem Impactor** in position.

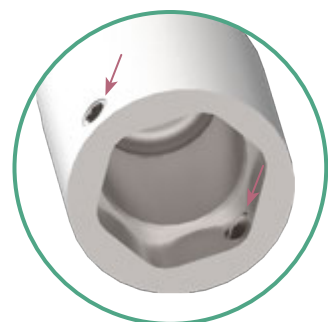

Always verify the medial and lateral set screws are not obstructing the taper recess before tapping the assembly together. Obstruction of the set screws inside the taper recess may result in an unsuccessful connection. The **Set Screwdriver Adapter** can be used to retract the set screw.

Instruments

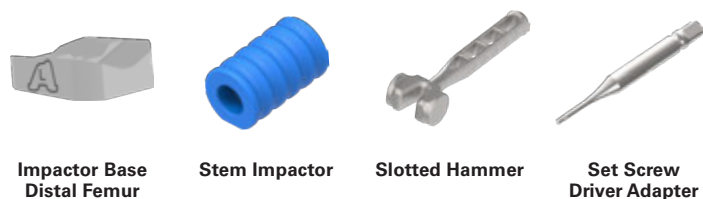

# G. Implant Assembly

Connect the **Set Screw Torque Limiter** to the **Driver Handle** and tighten the medial and lateral set screws. The **Set Screw Torque Limiter** is used to ensure an appropriate amount of torque is applied to prevent over-tightening.

**Note :**  
Do not use the **Torque Limiter** to loosen a set screw if this is required.

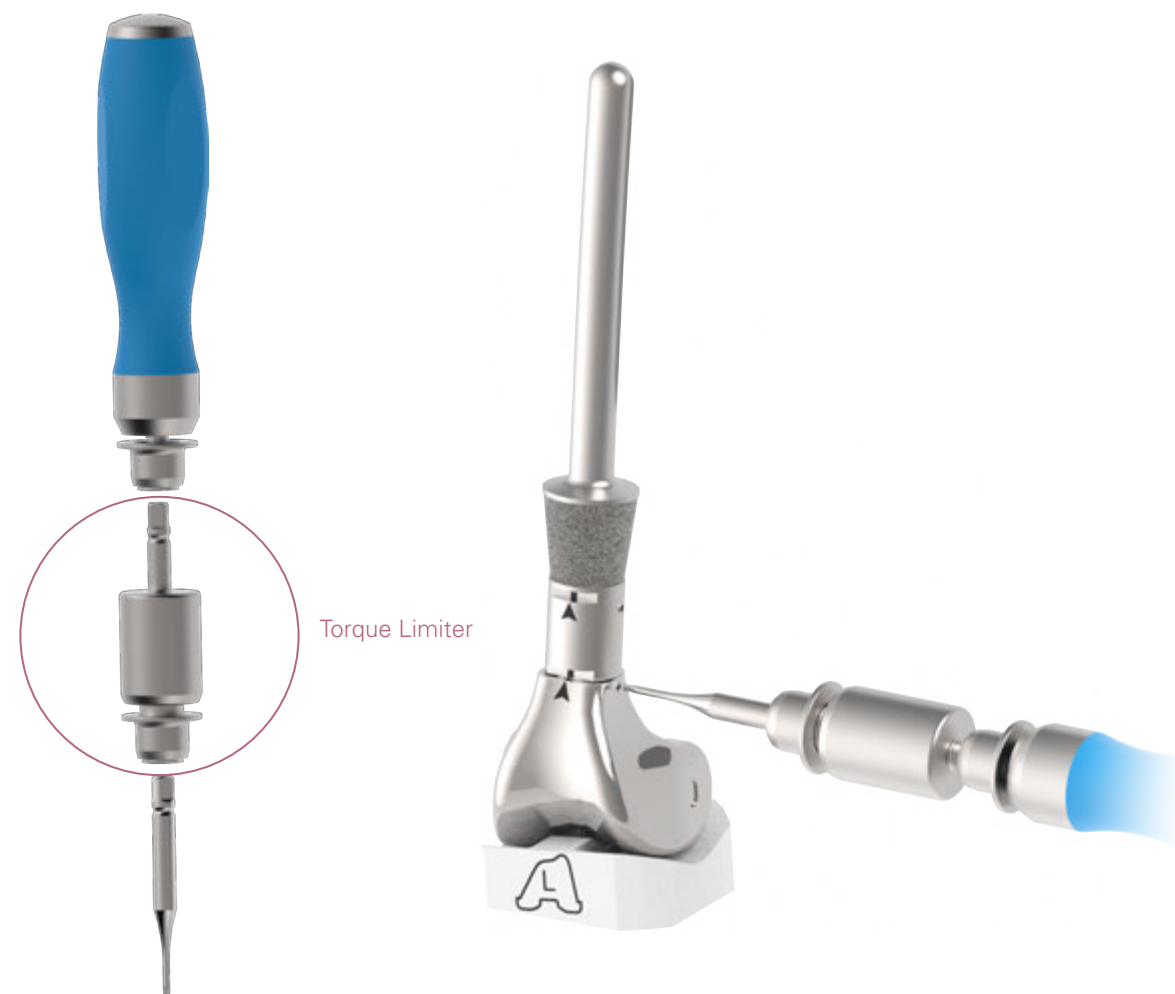

Instruments



# G. Implant Assembly

If a tibial stem is selected, assemble the tibial baseplate implant and tibial stem.

Remove the existing distal plug on the implant with the **Screwdriver Adapter T30**.

Place the selected tibial stem on the **Proximal Tibial Impactor Base**. Manually thread the selected tibial extension stem onto the baseplate.

Attach the **Torque Wrench 15 N-m** handle to the **Torque Wrench Adapter** that corresponds to the selected stem diameter.

Place the **Tibial Baseplate Wrench** over the baseplate. Complete tightening of the tibial implant assembly by applying 15 N-m of torque using the **Torque Wrench** assembly.



Instruments



Impactor Base Proximal Tibia    Driver Handle    Screwdriver Adapter, T30    Torque Wrench Adapter 9 / 12.5 / 14 mm    Torque Wrench 15 N-m    Tibial Baseplate Wrench

# H. Implantation

If a cemented tibial stem is selected, use the **Tibial Cement Restrictor Inserter** to introduce the selected cement restrictor to an adequate depth in the canal. Use the indicators on the shaft to set the depth.



The etched marking **C70** indicates the appropriate depth of the 70 mm cemented tibial stem

The diameter of cemented stem drill is 9 mm. Use cement restrictor size 8 to ensure smooth insertion

Cement Restrictor, I-Type		
Cat. No.	Size	Canal size (mm)
1907-1008	# 8	8 - 9

Instruments



Tibial Cement Restrictor Inserter



# H. Implantation

Attach the **Tibial Baseplate Driver** to the **Modular Handle**.

Insert the tip of the **Tibial Baseplate Driver** into the center hole of the tibial baseplate implant, then lock the tibial implant assembly.

Apply bone cement to proximal tibial resection and the distal surface of the baseplate. If using a cemented tibial stem, add cement to the prepared tibial canal.

Place the tibial implant assembly onto the prepared tibial surface. Attach the **Tibial Baseplate Impactor** to the **Modular Handle** and impact the tibial implant assembly until fully seated and in proper contact with the bone.



Instruments



Modular Handle Tibial Baseplate Driver Tibial Baseplate Impactor

# H. Implantation

If a cemented stem is selected for the femoral construct, use the **Cement Restrictor Inserter** to introduce the selected cement restrictor to an adequate depth in the canal. Use the indicators on the shaft to set the depth.

Fill the femoral canal and around the femoral implant assembly with cement, then advance the femoral prosthesis into the canal manually until fully seated onto the prepared bone surface. Use the **Femoral Impactor** if needed.



The etched marking **C125** indicates the appropriate depth of the 125 mm cemented stem.

Use the cement restrictor that is one size smaller than the diameter of the last reamer used to allow smooth insertion.

Align the rotational alignment mark on the femoral stem by referencing the rotational reference mark previously made on the anterior cortex of the femur.

Instruments

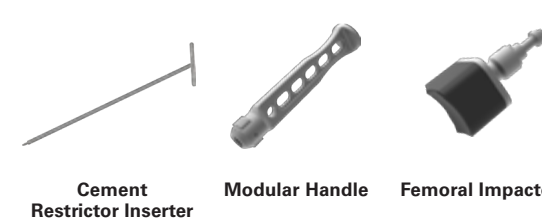

Cement Restrictor Inserter Modular Handle Femoral Impactor

# H. Implantation

Perform a final check to confirm the optimal tibial insert thickness with the last **Tibial Insert Trial**. Insert using the **Tibial Insert Handle** as described in previous steps.

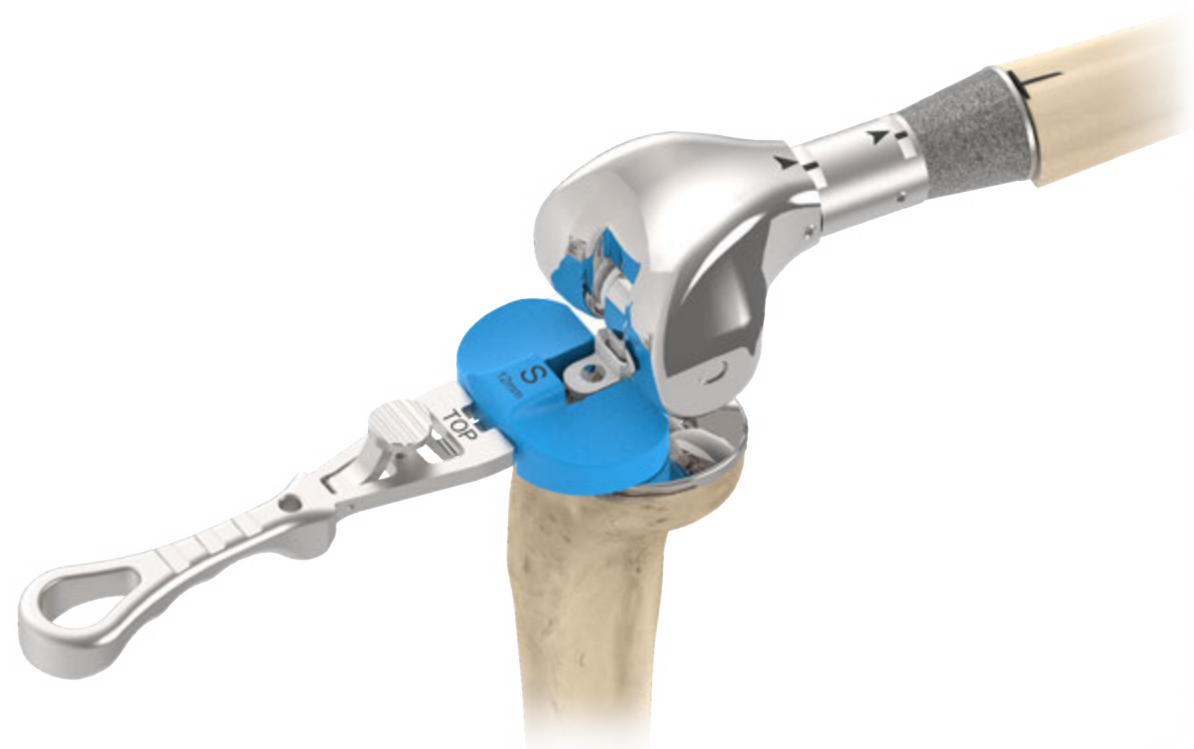

Instruments



Tibial Insert Trial

Tibial Insert Trial Handle

# H. Implantation

With the knee in flexion, place the selected tibial insert onto the implanted tibial baseplate assembly, making sure to maintain alignment with the hinge post of the distal femoral component.

With the knee in full extension, secure the tibial insert to the femoral prosthesis by tightening the built-in set screw inside the tibial insert with **Insert Set Screwdriver** to apply appropriate fixation torque.

Tighten the set screw until fully connected within the distal femoral component, confirming with the depth mark on the screwdriver.

Align the depth mark on the screwdriver according to the selected size of tibial insert. Align to the line marked S for size #S tibial insert; align the line marked M for size #M tibial insert.

If the depth mark is achieved but the torque limiter has not engaged, continue apply torque until engaged;

If the torque limiter is engaged before the depth mark is achieved, then the screw may not be correctly connected to the femoral component. Confirm the femoral assembly is fully seated in the tibial insert, then re-tighten the set screw.



Instruments



Insert Set Screwdriver



# Proximal Femoral Replacement



## Proximal Femoral Assembly



Femoral Head

Metal : 22 / 26 / 28 / 32 / 36 mm  
 Ceramic : 28 / 32 / 36 / 40 mm



Low Profile



Trochanteric

Proximal Femoral Component

Built-in 15° Anteversion  
 Length : 64 mm Left and Right



Claw

Length : 50 / 80 mm



Segment

Length : 25 through 220 mm  
 ( 30-220 mm in 10 mm Increments )



Non-coated Cemented

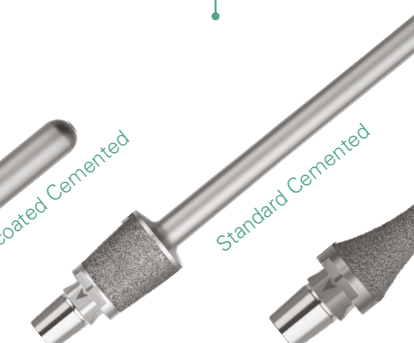

Standard Cemented

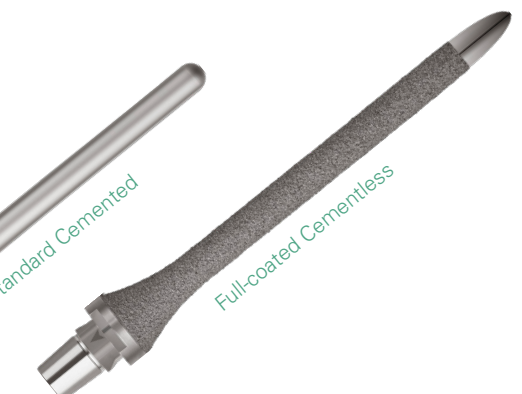

Full-coated Cementless

Extension Stem

Cemented Stem Length : Straight 100 / 125 mm Curved 125 / 150 mm  
 Diameter : 9 / 11 / 13 / 15 / 17 mm  
 Full-coated Stem Length : 150 / 200 mm  
 Diameter : 11 / 13 / 15 / 17 mm

# A. Pre-operative Planning

Plan the proper combination of implants with the **Resection Template**.

The length for standard proximal femoral components is 64 mm, the etched marking C on the medial side of the template indicates the extra-medullary 31 mm of titanium plasma spray coating section on the Standard Cemented Stem, while the rest of the cutouts indicate the additional segment length options.

The etched marking NC on the lateral side of the template indicates the extra-medullary 6mm on the Non-Coated Cemented stem or the Full-Coated Cementless stem, while the rest of the cutouts indicate the additional segment length options.

Please note the final combination of implants may be different at the actual time of surgery.

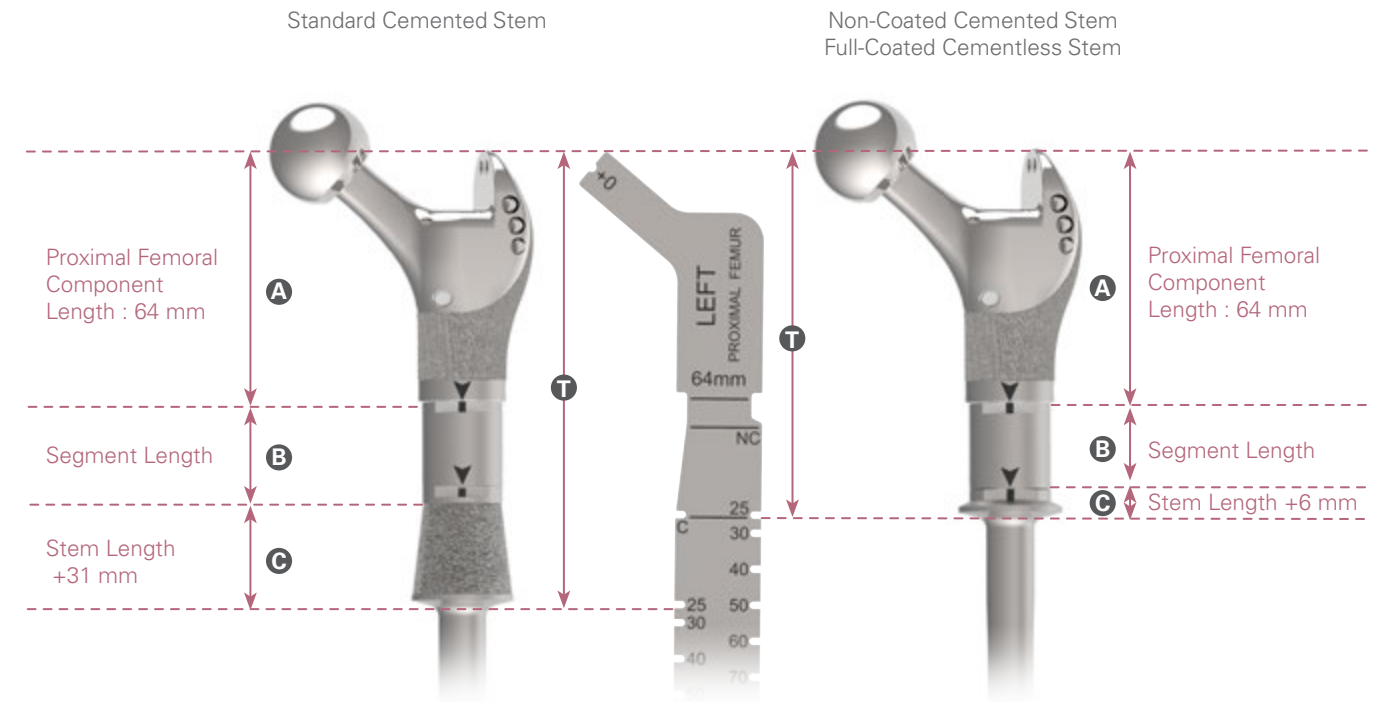

Reference Chart for Standard Cemented Stem			
T Resection Length	A Component	B Segment	C Stem
95 mm	Proximal Femoral Component Length 64 mm		Standard Cemented Stem +31 mm
120 mm		25 mm	
125 mm		30 mm	
135 mm		40 mm	
145 mm		50 mm	
155 mm		60 mm	
165 mm		70 mm	
175 mm		80 mm	
185 mm		90 mm	
195 mm		100 mm	
205 mm		110 mm	
215 mm		120 mm	
225 mm		130 mm	
235 mm		140 mm	
245 mm		150 mm	
255 mm		160 mm	
265 mm		170 mm	
275 mm		180 mm	
285 mm		190 mm	
295 mm		200 mm	
305 mm	210 mm		
315 mm	220 mm		

Reference Chart for Non-Coated Cemented Stem and Full-Coated Cementless Stem			
T Resection Length	A Component	B Segment	C Stem
70 mm	Proximal Femoral Component Length 64 mm		Non-Coated Cemented Stem Or Full-Coated Cementless Stem +6 mm
95 mm		25 mm	
100 mm		30 mm	
110 mm		40 mm	
120 mm		50 mm	
130 mm		60 mm	
140 mm		70 mm	
150 mm		80 mm	
160 mm		90 mm	
170 mm		100 mm	
180 mm		110 mm	
190 mm		120 mm	
200 mm		130 mm	
210 mm		140 mm	
220 mm		150 mm	
230 mm		160 mm	
240 mm		170 mm	
250 mm		180 mm	
260 mm		190 mm	
270 mm		200 mm	
280 mm	210 mm		
290 mm	220 mm		

## B. Femoral Osteotomy

Measure the appropriate resection length by aligning the **Resection Template** to the level of the most distal medial condyle and mark a resection reference line. Create an anterior reference mark(L) to align with the indicator on the stem trial and the implant.

Perform the femoral osteotomy at the reference resection line perpendicular to the shaft

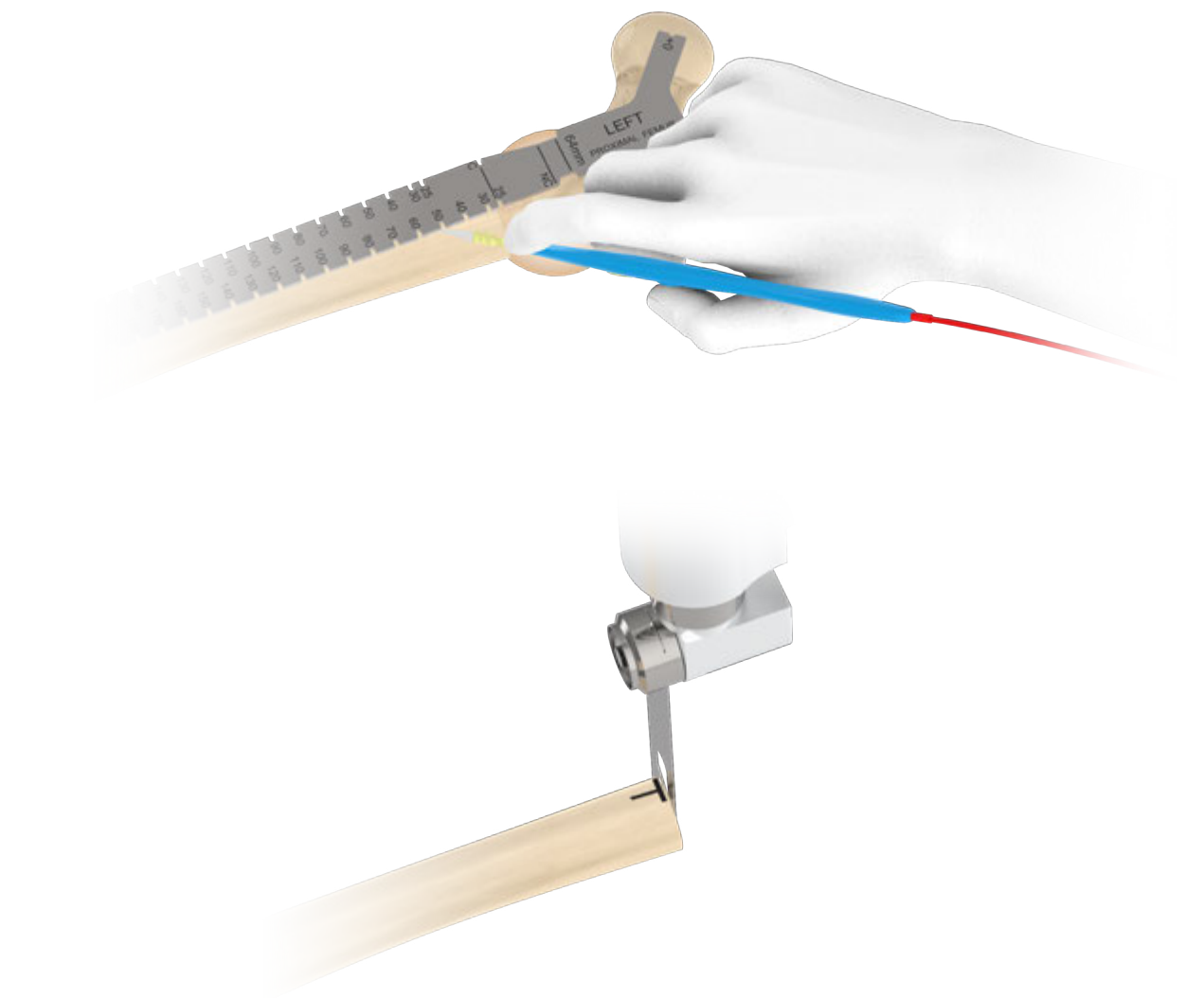

Instruments



Resection Template

## C. Canal Preparation

For the standard cemented stem and non-coated cemented stem, progressively ream the canal with the **Straight Stem Reamer** in 1 mm increments until the appropriate diameter and depth is achieved as indicated on the etched 'C' markings on the reamers. A stem diameter of 1~2 mm less than the final reamer is preferred for an adequate cement mantle.

For the full-coated cementless stem, progressively ream the canal with the **Straight Stem Reamers** that have 1 mm increments until the appropriate diameter and depth is achieved as indicated on the etched 'P' markings on the reamers. A stem diameter equal to the final reamer is recommended for an optimal press-fit. Optional reamer diameter of 11.5 / 13.5 / 15.5 / 17.5 mm are also included for the finer press-fit adjustment.

For a curved stem, there may need to be an additional difference in diameter between the final reamer and selected stem.



**Example of reaming for standard cemented stem or non-coated cemented stem.**

The etched marking C125 indicates an appropriate depth for a 125 mm cemented stem.

**Example of reaming for full coated cementless stem.**

The etched marking P150 indicates an appropriate depth for a 150 mm full coated cementless stem.

Instruments



Straight Stem Reamer  
Diameter 8~21 mm

# C.Canal Preparation

Stem Options Reference Chart

	Straight Stem	Curved Stem
Standard Cemented Stem	9 mm diameter x 100 mm Length	9 mm diameter x 125 mm Length
	11 mm diameter x 100 mm Length	11 mm diameter x 125 mm Length
	13 mm diameter x 100 mm Length	13 mm diameter x 125 mm Length
	15 mm diameter x 100 mm Length	15 mm diameter x 125 mm Length
	17 mm diameter x 100 mm Length	17 mm diameter x 125 mm Length
	9 mm diameter x 125 mm Length	9 mm diameter x 150 mm Length
	11 mm diameter x 125 mm Length	11 mm diameter x 150 mm Length
	13 mm diameter x 125 mm Length	13 mm diameter x 150 mm Length
	15 mm diameter x 125 mm Length	15 mm diameter x 150 mm Length
	17 mm diameter x 125 mm Length	17 mm diameter x 150 mm Length
Non-coated Cemented Stem	9 mm diameter x 100 mm Length	9 mm diameter x 125 mm Length
	11 mm diameter x 100 mm Length	11 mm diameter x 125 mm Length
	13 mm diameter x 100 mm Length	13 mm diameter x 125 mm Length
	15 mm diameter x 100 mm Length	15 mm diameter x 125 mm Length
	17 mm diameter x 100 mm Length	17 mm diameter x 125 mm Length
	9 mm diameter x 125 mm Length	9 mm diameter x 150 mm Length
	11 mm diameter x 125 mm Length	11 mm diameter x 150 mm Length
	13 mm diameter x 125 mm Length	13 mm diameter x 150 mm Length
Full Coated Cementless Stem	N/A	N/A
	11 mm diameter x 150 mm Length	11 mm diameter x 150 mm Length
	13 mm diameter x 150 mm Length	13 mm diameter x 150 mm Length
	15 mm diameter x 150 mm Length	15 mm diameter x 150 mm Length
	17 mm diameter x 150 mm Length	17 mm diameter x 150 mm Length
	N/A	N/A
	11 mm diameter x 200 mm Length	11 mm diameter x 200 mm Length
	13 mm diameter x 200 mm Length	13 mm diameter x 200 mm Length
	15 mm diameter x 200 mm Length	15 mm diameter x 200 mm Length
	17 mm diameter x 200 mm Length	17 mm diameter x 200 mm Length



# C.Canal Preparation

For the standard cemented stem and non-coated cemented stem, connect the **Cemented Stem Barrel Reamer** to the appropriate **Reamer Guide Rod** and advance into the canal to prepare the resected proximal femur.

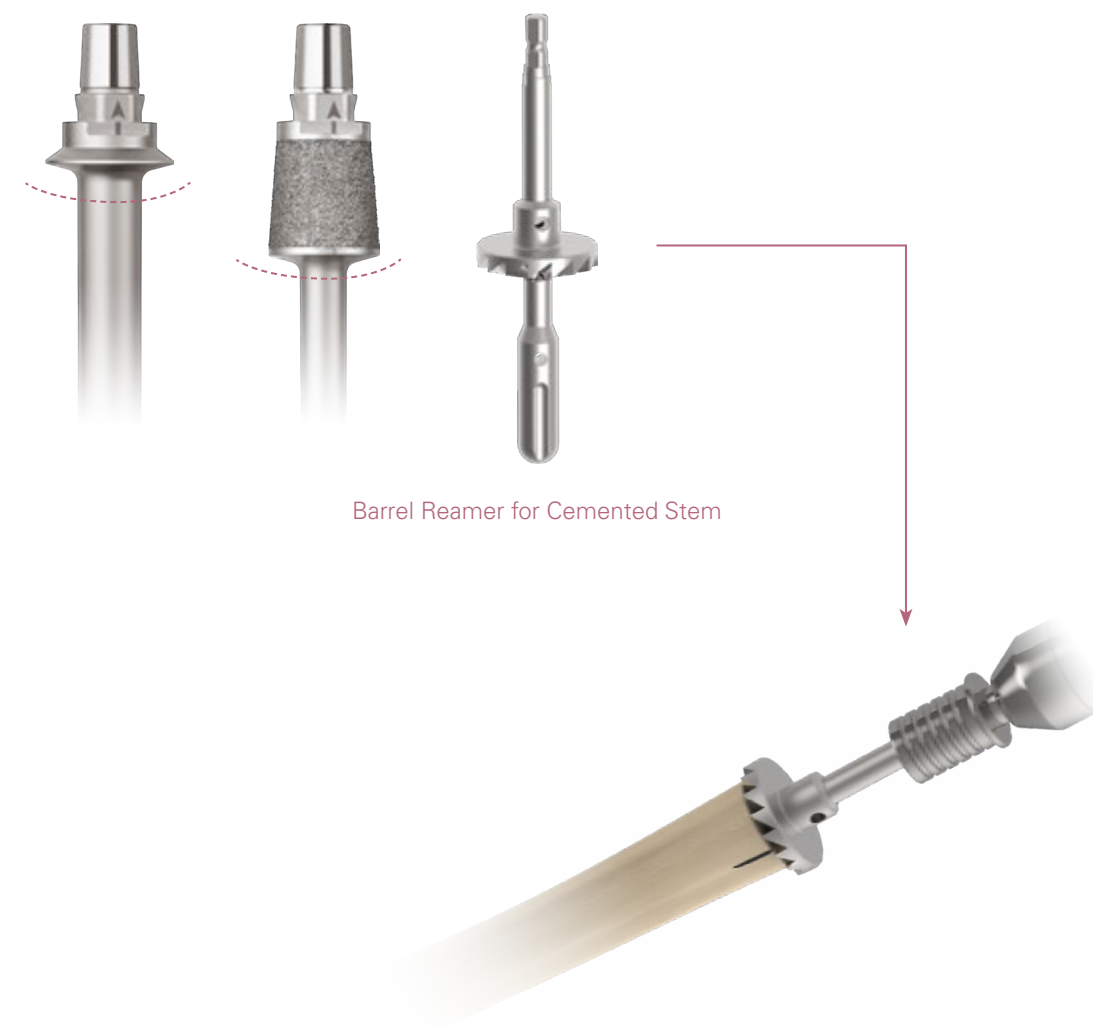

Barrel Reamer for Cemented Stem

Instruments



Cemented Stem Barrel Reamer Reamer Guide Rod Diameter 10-21 mm

# C. Canal Preparation

For the cementless stem, connect the **Cementless Stem Barrel Reamer** to the appropriate **Reamer Guide Rod** and advance into the canal to prepare the resected proximal femur.

Ream to the distal cut-out marking on the barrel reamer. If less than 3 mm of cortical bone around the reamer is observed, stop reaming. The planned implant construct will be 8 mm longer than the original measured plan. The cementless stem will sit above the bone (proud) by 14 mm (8 mm coated and 6 mm non-coated area on the proximal end of stem). The length of the implant construct may be adjusted selecting a shorter segment or making other adjustment.

If there is 3 mm or more of cortical bone around the barrel reamer after the initial reaming step, continue reaming to the proximal cut-out marking on the barrel reamer. The planned implant construct will match the original measured plan. The cementless stem will sit above the bone (proud) by 6mm (6mm non-coated area on the proximal end of the stem). This will be the non-coated area on the proximal end of the stem.

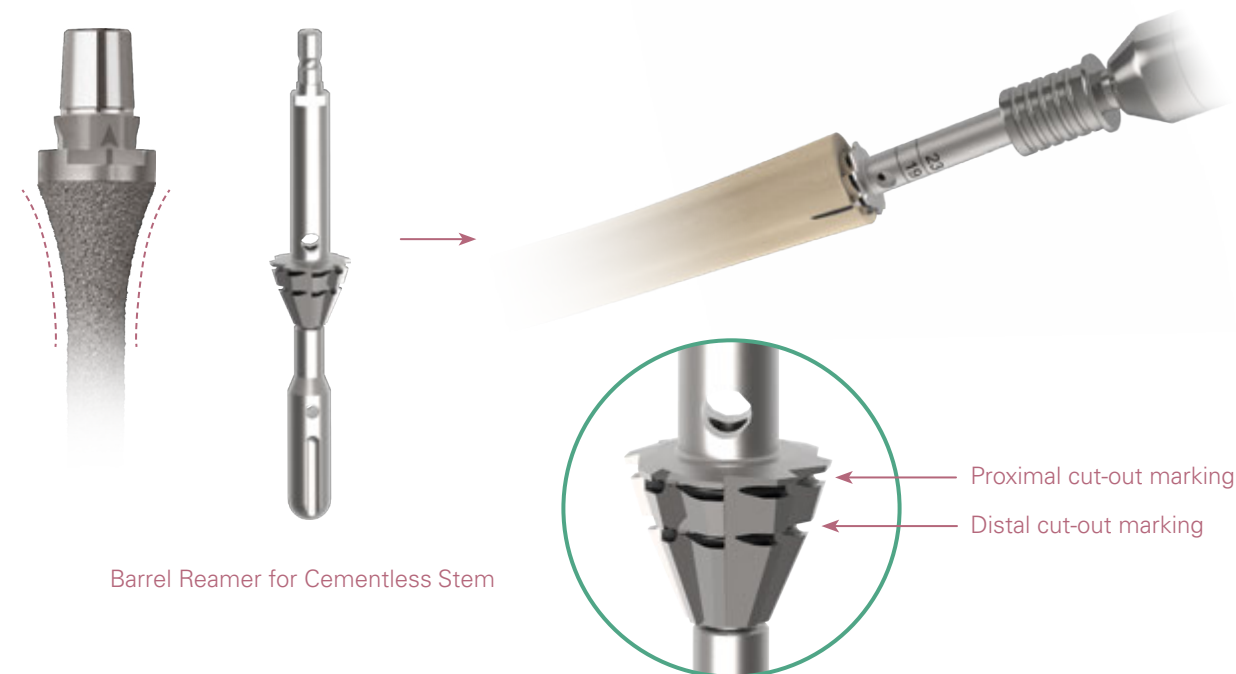

Instruments



**Cementless Stem Barrel Reamer**  
**Reamer Guide Rod**  
Diameter 10~21 mm

# D. Trialing

Choose the **Stem Trial Body** and **Stem Trial Adapter** that corresponds to selected cemented or cementless stem size.

Attach the **Stem Trial Body** into the **Stem Trial Adapter** (see image part 1 and 2, the anterior indicators shall align together).

Insert the **Screwdriver Adapter T30** into the top of the **Stem Trial Adapter** and secure with the **Driver Handle** (see image part 3).

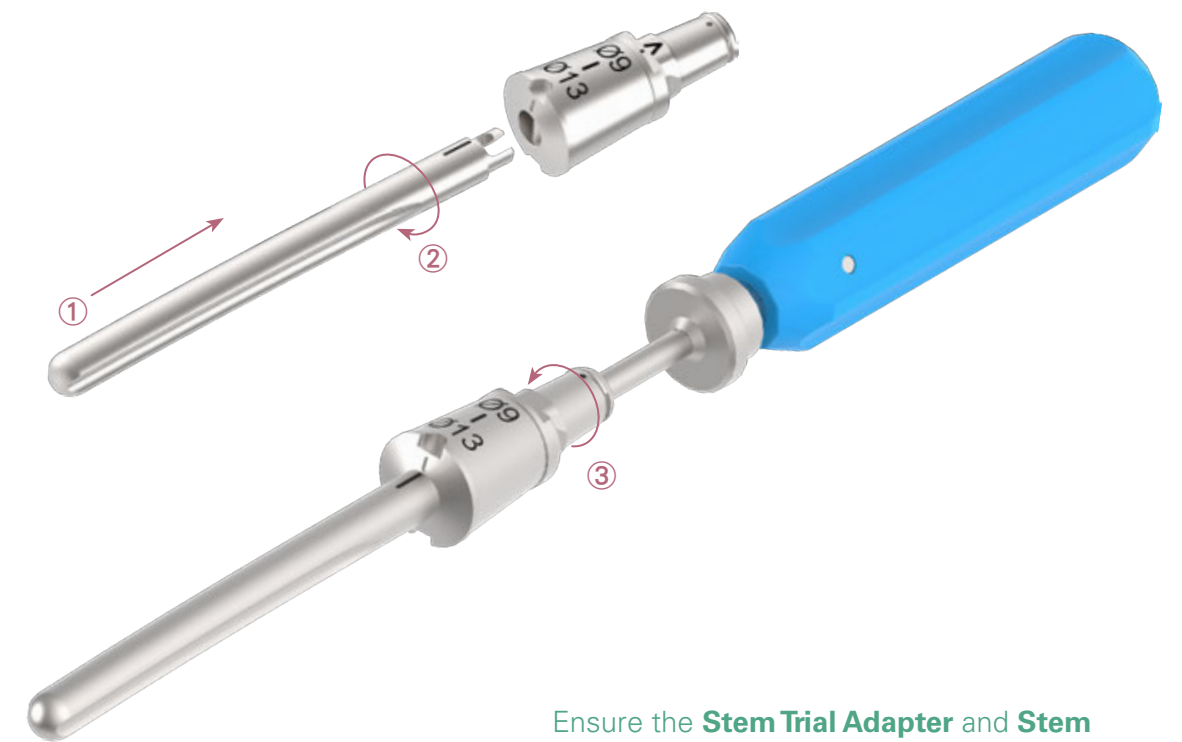

Ensure the **Stem Trial Adapter** and **Stem Trial Body** are fully attached and locked into position prior to trialing.

Instruments



**Cemented Stem Trial Body**  
Diameter 9~17 mm  
**Cemented Stem Trial Adapter**  
Diameter 9~13 mm  
Diameter 15~19 mm  
**Cementless Stem Trial Body**  
Diameter 11~17 mm  
**Cementless Stem Trial Adapter**  
Diameter 11~17 mm  
**Driver Handle**  
**Screwdriver Adapter, T30**



# D. Trialing

Identify the correct length **Segment Trial** to restore femoral length using the chart below. During trialing, multiple trial segments may be combined to represent the ideal monolithic implant assembly length.

Attach the selected **Segment Trial(s)** to the selected **Proximal Femoral Trial**. Attach the **Proximal Femoral Trial/Segment Trial** assembly to the **Stem Trial Adapter/Stem Trial Body** assembly.

**Segment Trial Reference Chart**

Segment (mm)	Segment Trial (mm)
25	25
30	30
40	40
50	50
60	60
70	70
80	30 + 50
90	40 + 50
100	40 + 60
110	110
120	50 + 70
130	60 + 70
140	30 + 110
150	150
160	50 + 110
170	60 + 110
180	70 + 110
190	40 + 150
200	50 + 150
210	60 + 150
220	70 + 150

Combining shorter **Segment Trials** to mimic longer length of segments



Instruments



**Segment Trial**  
25-150 mm  
**Trochanteric Proximal Femoral Trial**  
Left/Right  
**Low Profile Proximal Femoral Trial**  
Left/Right

# D. Trialing

Place the femoral trial assembly onto the prepared femoral surface. Align the anterior reference mark on the bone with the anterior reference line on the **Stem Trial**.

Perform trial reduction by using the **Femoral Head Trial** and appropriate acetabular trial components to complete trialing.

Position the **Taper Separator** at the junction between each trial component and separate by levering the trials.

If it is difficult to remove the stem trial assembly manually, remove the stem trial by connecting the **Stem Trial Remover** to the end of the trunnion. Utilize the **Slotted Hammer** remove the stem trial if needed.

**Metal Head**

- Ø22 mm : +0 / +3 / +6 / +9 mm
- Ø26 mm : -2 / +0 / +3 / +6 / +9 mm
- Ø28 mm : -3 / +0 / +2.5 / +5 / +7.5 / +10 mm
- Ø32 mm : -3 / +0 / +2.5 / +5 / +7.5 / +10 mm
- Ø36 mm : -3 / +0 / +2.5 / +5 / +7.5 / +10 mm

**Ceramic Head**

- Ø28 mm : -2.5 / +1 / +4 mm
- Ø32 mm : -3 / +1 / +5 / +8 mm
- Ø36 mm : -3 / +1 / +5 / +9 mm
- Ø40 mm : -3 / +1 / +5 / +9 mm

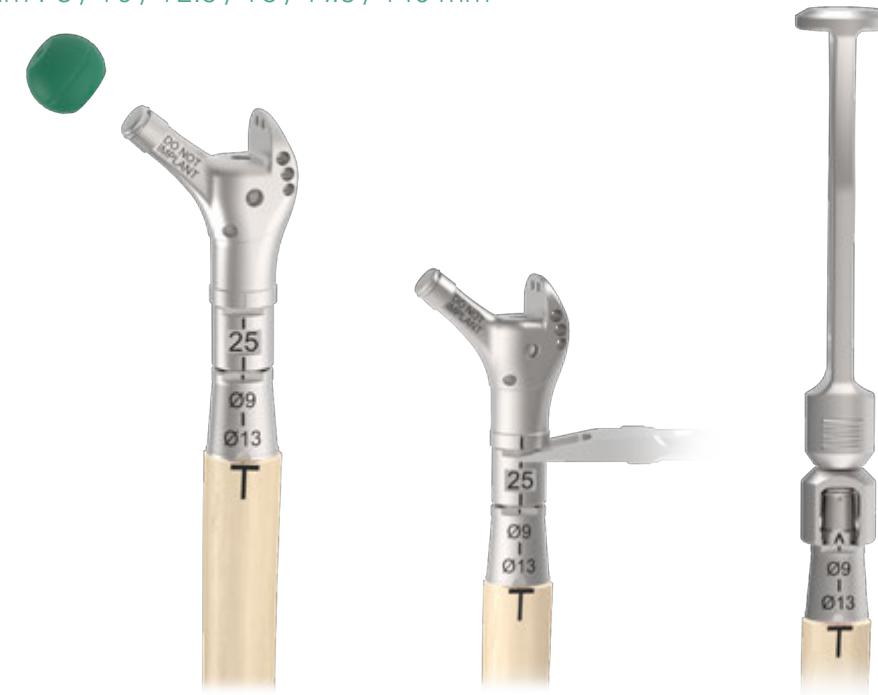

Instruments



**Femoral Head Trial** **Taper Separator** **Modular Handle** **Stem Trial Remover** **Slotted Hammer**

# E. Implant Assembly

Assemble the implants starting with proximal femoral component and the segment (if selected), then the selected stem.

Place the selected proximal femoral component onto the **Proximal Femur Impactor Base**. Verify the medial and lateral set screws are not obstructing the taper recess, loosening the set screws if needed.

Connect the proximal femoral component with the correct segment component by aligning the anterior mark and tapping the prosthesis with the **Stem Impactor** in position.

Confirm the medial and lateral set screws on the segment is not obstructing the taper recess. Connect the selected stem component to the femoral component/segment assembly by aligning the anterior mark and tapping the prosthesis with the **Stem Impactor** in position.

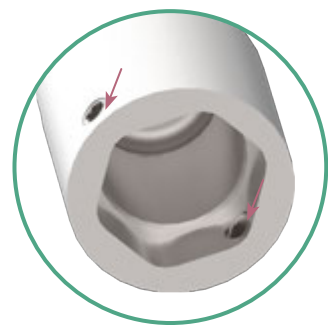

Always verify the medial and lateral set screws are not obstructing the taper recess before tapping the assembly together. Obstruction of the set screws inside the taper recess may result in an unsuccessful connection. The **Set Screwdriver Adapter** can be used to retract the set screw.

Note :  
All proximal femoral implant components have a built-in 15 degrees of anteversion.



Instruments

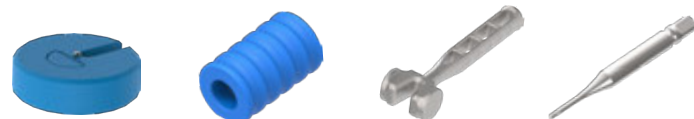

Impactor Base Proximal Femur    Stem Impactor    Slotted Hammer    Set Screw Driver Adapter

# E. Implant Assembly

Connect the **Set Screw Adapter**, and the **Set Screw Torque Limiter** to the **Driver Handle** and tighten the medial and lateral set screws. The **Set Screw Torque Limiter** is used to ensure an appropriate amount of torque is applied to prevent over-tightening.

Note :  
Do not use the **Torque Limiter** to loosen a set screw if this is required.

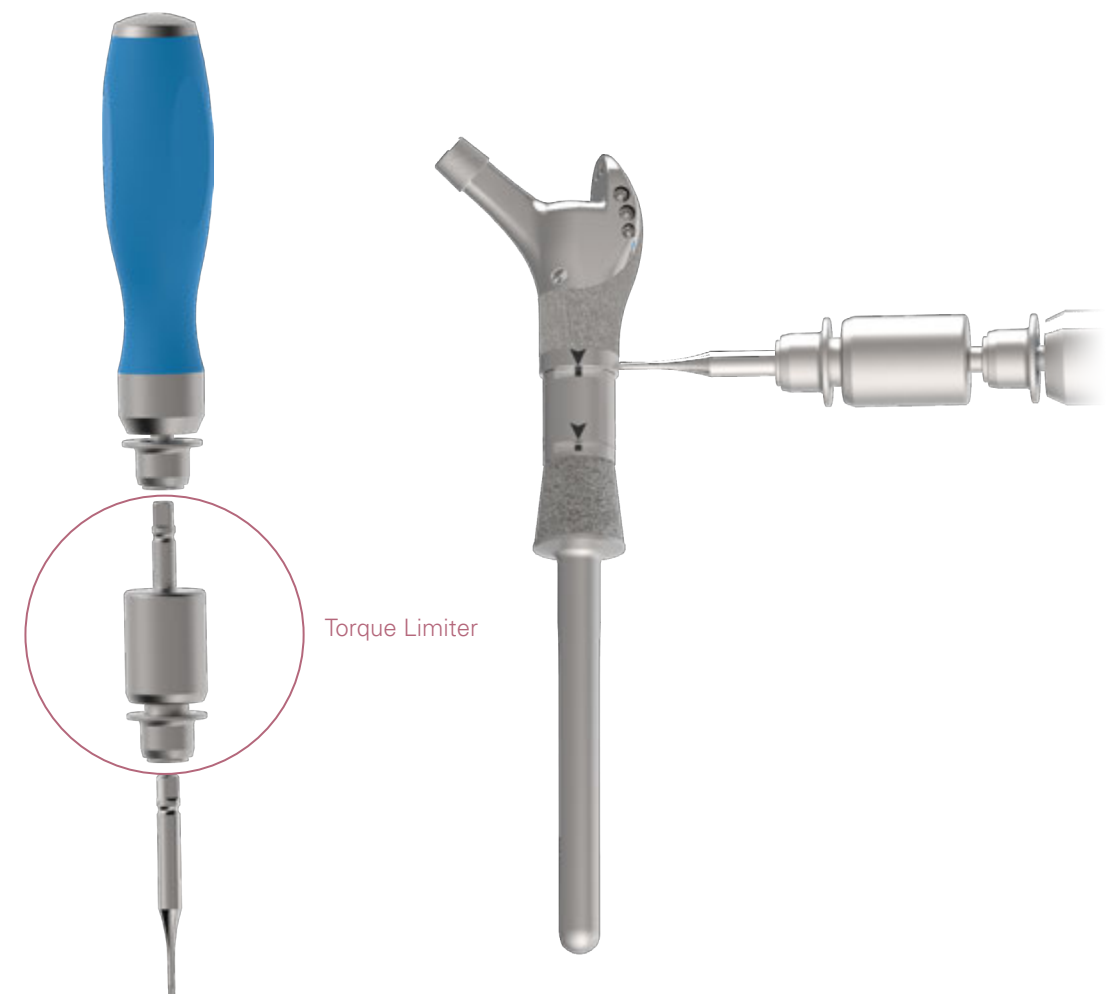

Instruments



Set Screw Driver Adapter    Set Screw Torque Limiter    Driver Handle



# E. Implant Assembly

If a cemented stem is selected for the femoral construct, use the **Cement Restrictor Inserter** to introduce the selected cement restrictor to an adequate depth in the canal. Use the indicators on the shaft to set the depth.



The etched marking **C125** indicates the appropriate depth of the 125 mm cemented stem.

Use the cement restrictor that is one size smaller than the diameter of the last reamer used to allow smooth insertion.



Cement Restrictor, I-Type		
Cat. No.	Size	Canal size (mm)
1907-1008	# 8	8 - 9
1907-1010	# 10	10 - 11
1907-1012	# 12	12 - 13
1907-1014	# 14	14 - 15
1907-1016	# 16	16 - 17
1907-1018	# 18	18 - 19

Instruments



Cement Restrictor Inserter

# F. Implantation

Advance the femoral prosthesis assembly into the canal by using the **Proximal Femoral Impactor** until the stem is seated properly with the bone. Rotational alignment may be set by referencing the mark previously made on the anterior cortex of the femur.

Perform a final trial reduction to confirm stability and leg length by using **Femoral Head Trials**. Connect the **Femoral Head Impactor** and **Universal Handle**. Impact the femoral head until it is firmly seated.

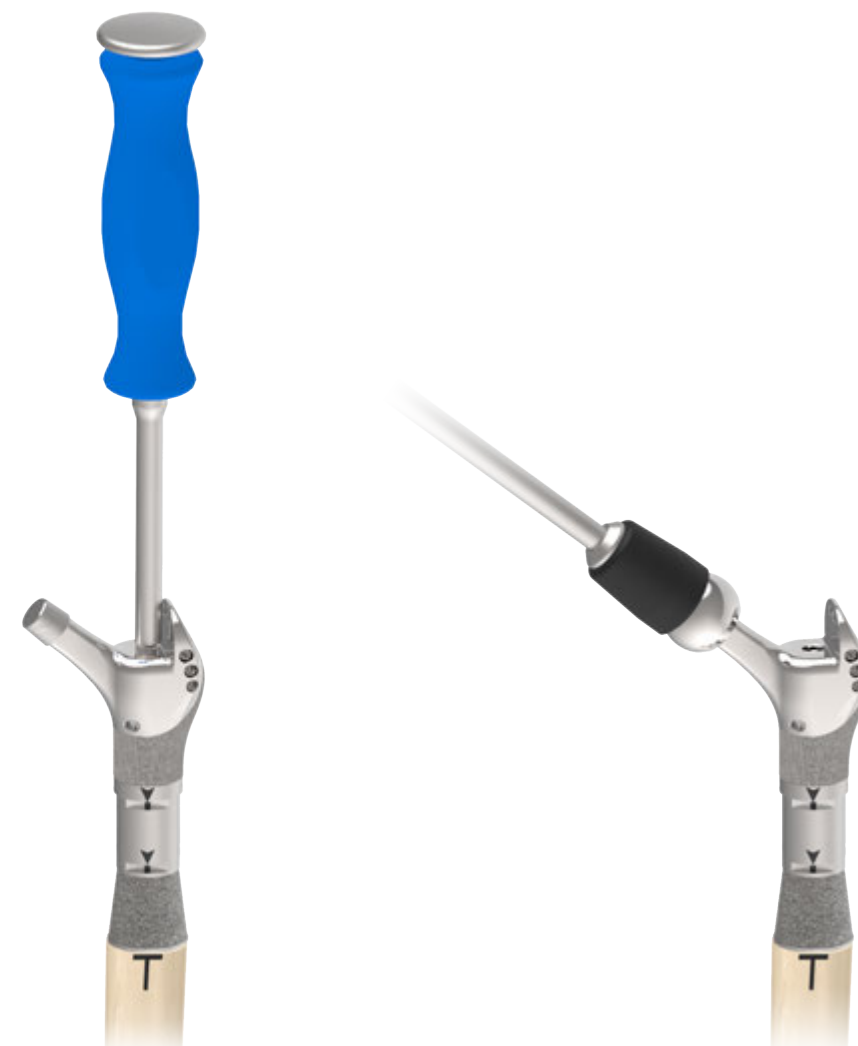

Instruments



Proximal Femoral Impactor



Femoral Head Trial



Femoral Head Impactor



Universal Handle

# F. Implantation

---

The **Claw Holder** can be used to help position the selected trochanteric claw implant to further enhance soft tissue fixation.



Instruments



Claw Holder

# Total Femoral Replacement

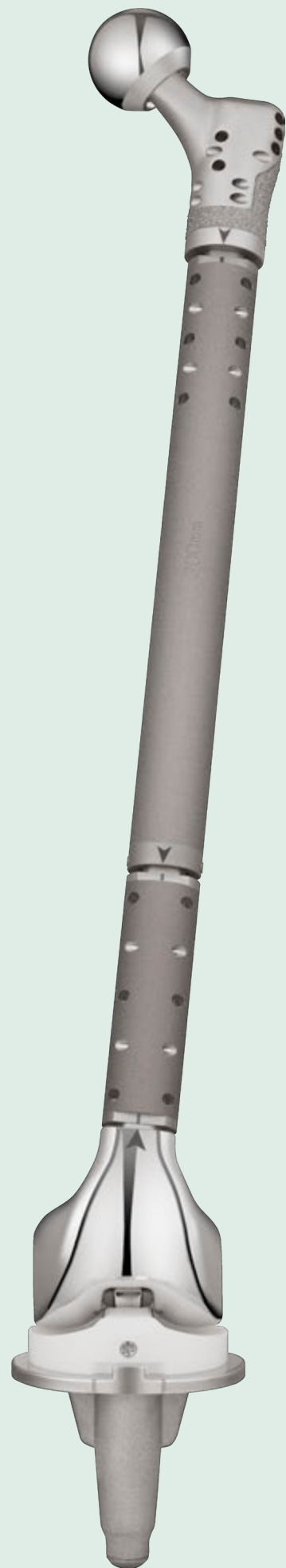

## Total Femoral Assembly



# A. Measure the Length of the Entire Femur

Plan the proper combination of components with the resection chart below.

The length for both the trochanteric and low-profile proximal femoral components is 64mm. The length for the distal femoral components is 55 mm. The length for the bridge component is 80 mm.

Please note the final combination of components may be different at the actual time of surgery.

Reference Chart for the Resection of Total Femoral Replacement				
Femur Length	Component	Bridge	Segment	Component
199 mm			0	
224 mm			25 mm	
229 mm			30 mm	
239 mm			40 mm	
249 mm			50 mm	
259 mm			60 mm	
269 mm			70 mm	
279 mm			80 mm	
289 mm			90 mm	
299 mm	Proximal Femoral Component 64 mm	Bridge Component 80 mm	100 mm	Distal Femoral Components 55 mm
309 mm				
319 mm				
329 mm				
339 mm				
349 mm				
359 mm				
369 mm				
379 mm				
389 mm				
399 mm				
409 mm				
419 mm				
429 mm				
439 mm				
449 mm				
459 mm				

Note: the length of XS distal femoral component is 50 mm, 5 mm less than standard component. The XS articular surface fit only with XS Insert and XS Baseplate. Please refer to the appendix for XS component preparation.

# B. Trialing

Identify the correct length **Segment Trial** to restore femoral length using the chart below. During trialing, multiple trial segments may be combined to represent the ideal monolithic implant assembly length.

Assemble the **Proximal Femoral Component Trial**, **Segment Trial**, **Bridge Trial** and **Distal Femoral Component Trial** together as outlined in previous sections of this surgical technique guide.

Femur Length (mm)	Segment (mm)	Segment Trial (mm)
200	0	—
225	25	25
230	30	30
240	40	40
250	50	50
260	60	60
270	70	70
280	80	30 + 50
290	90	40 + 50
300	100	40 + 60
310	110	110
320	120	50 + 70
330	130	60 + 70
340	140	30 + 110
350	150	150
360	160	50 + 110
370	170	60 + 110
380	180	70 + 110
390	190	40 + 150
400	200	50 + 150
410	210	60 + 150
420	220	70 + 150

Combining shorter **Segment Trials** to mimic longer length of segments



### Instruments



## B. Trialing

Prepare the tibia and **Tibial Assembly Trial** components as outlined in tibial preparation sections of this surgical technique guide.

Evaluate joint stability using the selected trial components. Switch to different thickness **Tibial Insert Trials** or other components as needed to obtain optimal stability and leg length.

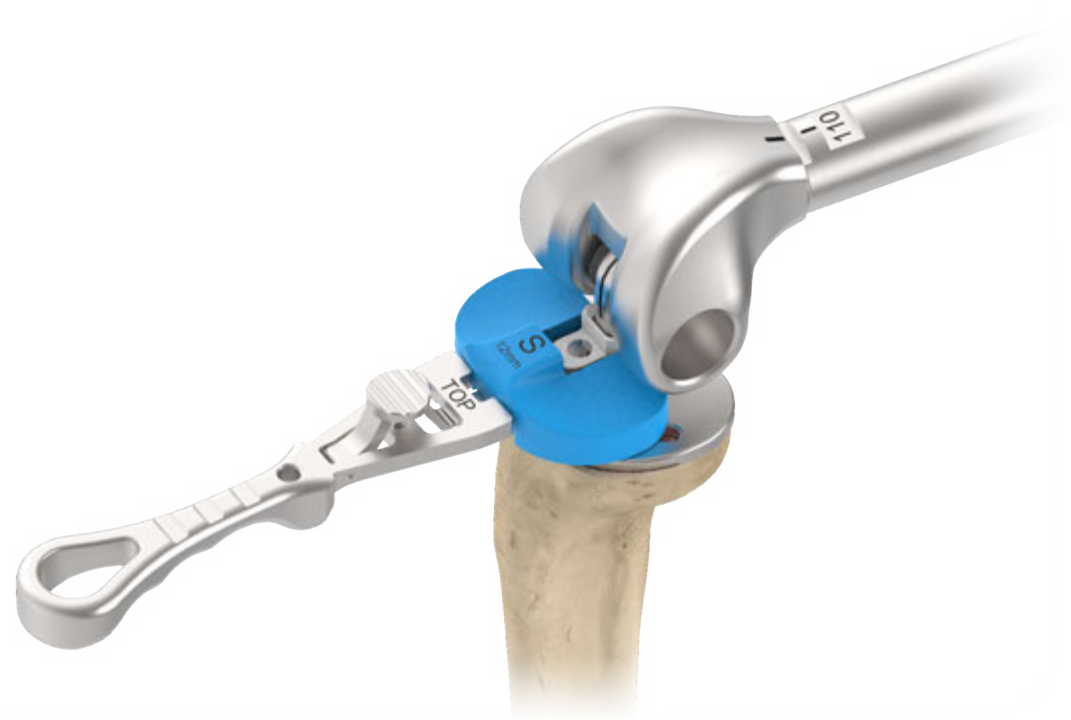

Instruments



Tibial Insert Trial

Tibial Insert Trial Handle

## C. Implant Assembly

Assemble the femoral prosthesis; the distal femoral component, segment component, bridge component, and the proximal femoral component together by tapping the prosthesis with the **Stem Impactor** and **Proximal Femoral Impactor** as outlined in previous sections of this surgical technique guide. Start with the distal femoral component placed on the **Distal Femoral Impactor Base**.

Secure the set screws on both sides of the segment and proximal/ distal femoral component with the **Set Screwdriver Adapter**, **Set Screw Torque Limiter** and **Driver Handle** as outlined in previous sections of this surgical technique guide.

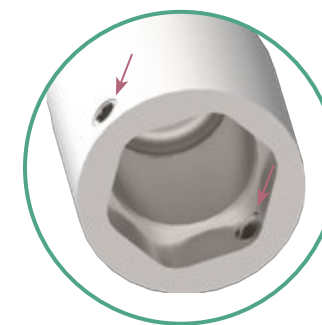

Always verify the medial and lateral set screws are not obstructing the taper recess before tapping the assembly together. Obstruction of the set screws inside the taper recess may result in an unsuccessful connection. The **Set Screwdriver Adapter** can be used to retract the set screw.

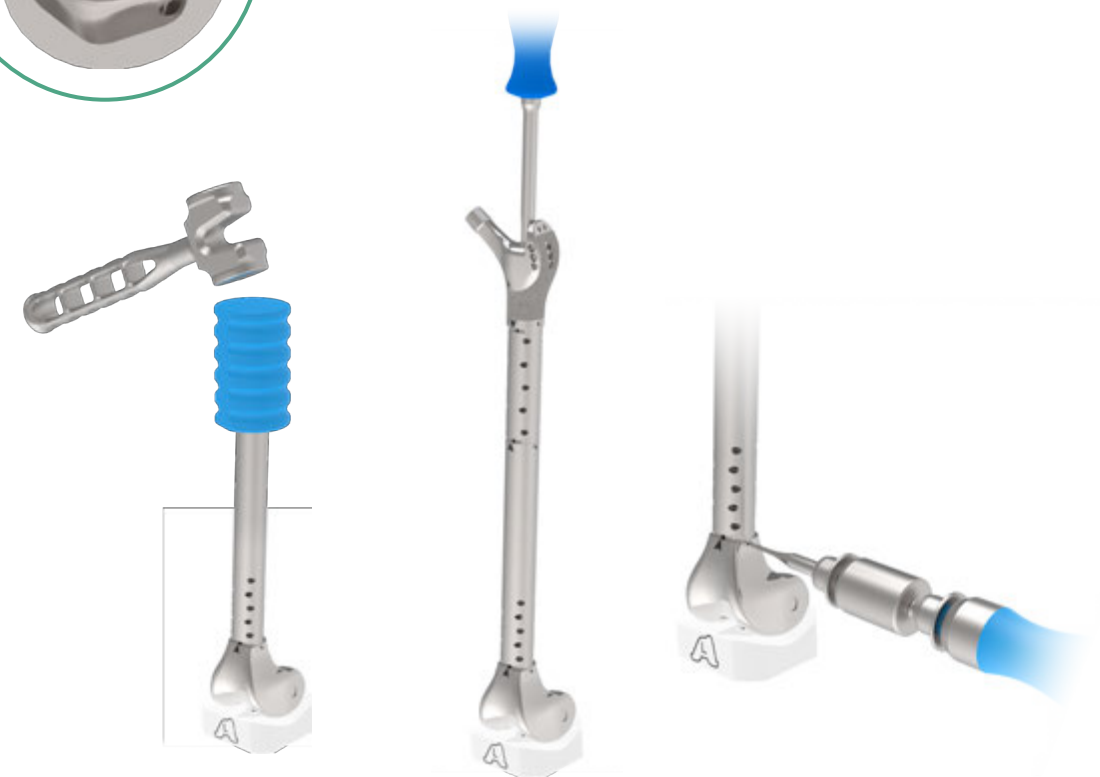

Instruments



Impactor Base Distal Femur

Stem Impactor

Proximal Femoral Impactor

Set Screw Driver Adapter

Set Screw Torque Limiter

Driver Handle

# C. Implant Assembly

Perform a final trial reduction to confirm stability and leg length by using **Femoral Head Trials**. Connect the **Femoral Head Impactor** and **Universal Handle**. Impact the femoral head until it is firmly seated.

The **Claw Holder** can be used to help position the selected trochanteric claw implant to further enhance soft tissue fixation.



Instruments



Femoral Head Trial



Femoral Head Impactor



Universal Handle



Claw Holder



# Proximal Tibial Replacement



## Proximal Tibial Assembly



### Press-fit Stem

Diameter : 10 to 24 mm (In 2 mm Increment)  
 Straight Stem Length : 30 / 75 / 100 / 150/ 200 mm  
 Curved Stem Length : 150 / 200 mm

### Offset Adapter

2 / 4 / 6 mm

### Femoral Component

6 Component Sizes (#1 to #6) Left and Right

### Tibial Insert

Size : S  
 7 Insert Thickness :  
 12 / 14 / 17 / 20 / 23 / 26 / 30 mm

### Proximal Tibial Component

Length : 81 mm  
 (With Minimal Insert Thickness)

### Segment

Length : 25 / 30 to 220 mm in 10 mm Increments

### Extension Stem

Cemented Stem Length : Straight 100 / 125 mm  
 Curved 125 / 150 mm  
 Diameter : 9 / 11 / 13 / 15 / 17 mm  
 Full-coated Stem Length : 150 / 200 mm  
 Diameter : 11 / 13 / 15 / 17 mm



# A. Pre-operative Planning

Plan the proper combination of components with the **Resection Template**.

The length for Standard proximal tibial components is 81mm, the etched marking **C** on the medial side indicates the extra-medullary 31mm of titanium plasma spray coating section on the Standard Cemented Stem, while the rest of the cutouts indicate the additional segment length options .

The etched marking **NC** on the lateral side indicates the extra-medullary 6 mm on the Non-Coated Cemented stem or the Full-Coated Cementless stem, while the rest of the cutouts indicate the additional segment length options.

Please note the final combination of components may be different at the actual time of surgery.

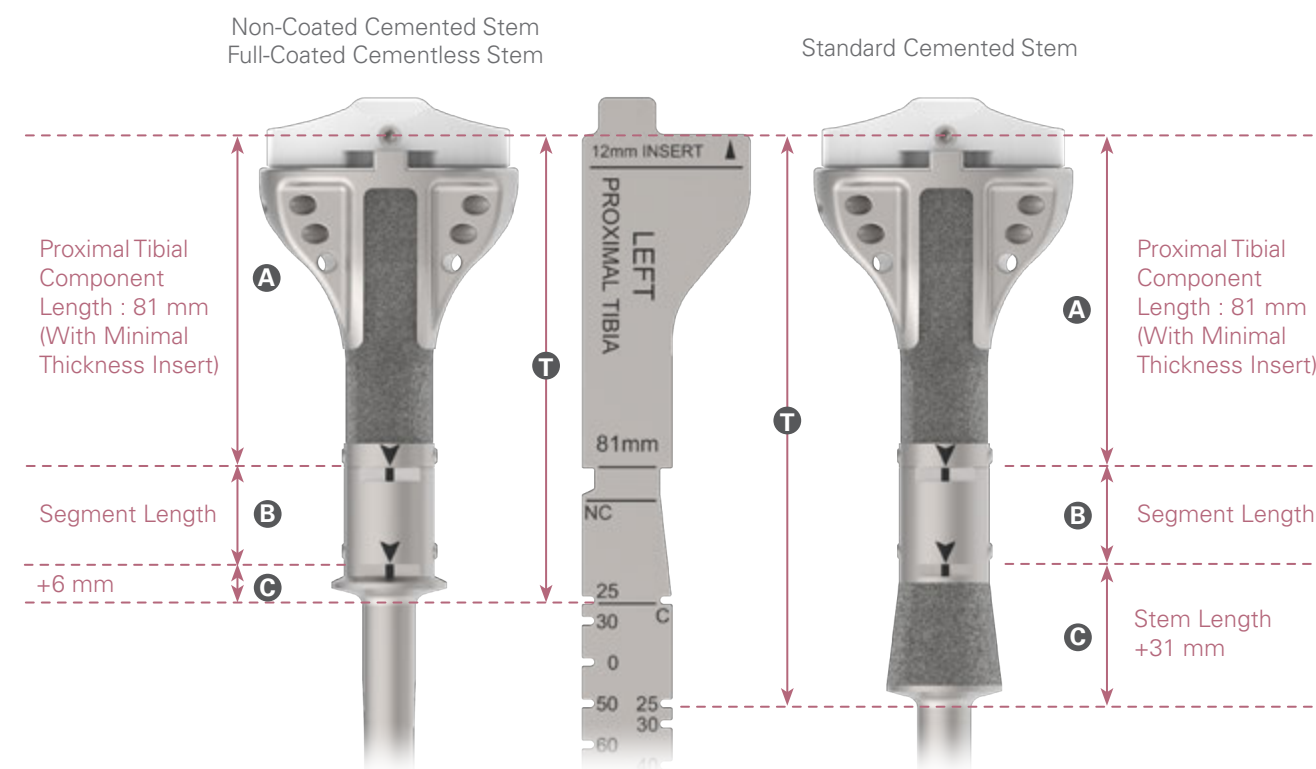

Reference Chart for Non-Coated Cemented Stem and Full-Coated Cementless Stem			
T Resection Length	A Component	B Segment	C Stem
87 mm	Proximal Tibial Component Length + 12mm Tibial Insert 81 mm		Non-Coated Cemented Stem
112 mm		25 mm	
117 mm		30 mm	
127 mm		40 mm	
137 mm		50 mm	
147 mm		60 mm	
157 mm		70 mm	
167 mm		80 mm	
177 mm		90 mm	
187 mm		100 mm	
197 mm		110 mm	
207 mm		120 mm	Full-Coated Cementless Stem +6 mm
217 mm		130 mm	
227 mm		140 mm	
237 mm		150 mm	
247 mm		160 mm	
257 mm		170 mm	
267 mm		180 mm	
277 mm		190 mm	
287 mm		200 mm	
297 mm	210 mm		
307 mm	220 mm		

Reference Chart for Standard Cemented Stem			
T Resection Length	A Component	B Segment	C Stem
112 mm	Proximal Tibial Component Length + 12mm Tibial Insert 81 mm		Standard Cemented Stem +31 mm
137 mm		25 mm	
142 mm		30 mm	
152 mm		40 mm	
162 mm		50 mm	
172 mm		60 mm	
182 mm		70 mm	
192 mm		80 mm	
202 mm		90 mm	
212 mm		100 mm	
222 mm		110 mm	
232 mm		120 mm	
242 mm		130 mm	
252 mm		140 mm	
262 mm		150 mm	
272 mm		160 mm	
282 mm		170 mm	
292 mm		180 mm	
302 mm		190 mm	
312 mm		200 mm	
322 mm	210 mm		
332 mm	220 mm		

Note: the length of XS proximal tibial component and the XS tibial insert is 73 mm, 8 mm less than standard component. The XS rotating platform fit only with XS tibial insert and XS femoral component. Please refer to the appendix for XS component preparation.

# B. Femoral Osteotomy

Measure the appropriate resection length by aligning the **Proximal Tibial Resection Template** to the appropriate reference point of the tibial plateau and mark a resection reference line. Create an anterior reference mark (L) to align with the indicator on the stem trial and the implant.

Perform the tibial osteotomy at the reference resection line perpendicular to the shaft.

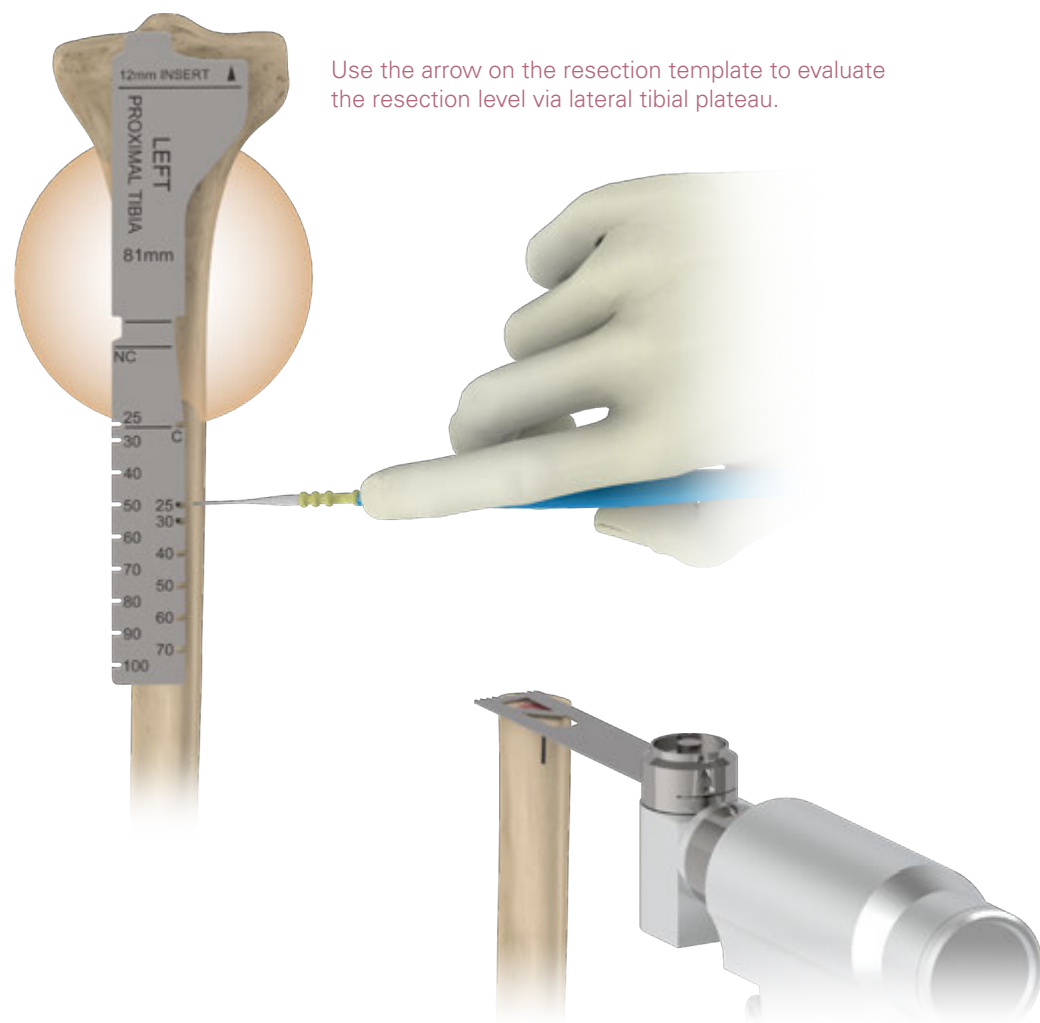

Instruments



Proximal Tibial Resection Template

# C. Canal Preparation

For the use of cemented stem, sequentially reaming the canal with the **Straight Stem Reamer** in 1 mm increment until the anticipated diameter and depth is achieved. A stem diameter 1~2 mm less than the final reamer is preferred for adequate cement mantle.

For the full-coated cementless stem, progressively ream the canal with the **Straight Stem Reamers** that have 1 mm increments until the appropriate diameter and depth is achieved as indicated on the etched 'P' markings on the reamers. A stem diameter equal to the final reamer is recommended for an optimal press-fit. Optional reamer diameter of 11.5 / 13.5 / 15.5 / 17.5 mm are also included for the finer press-fit adjustment.

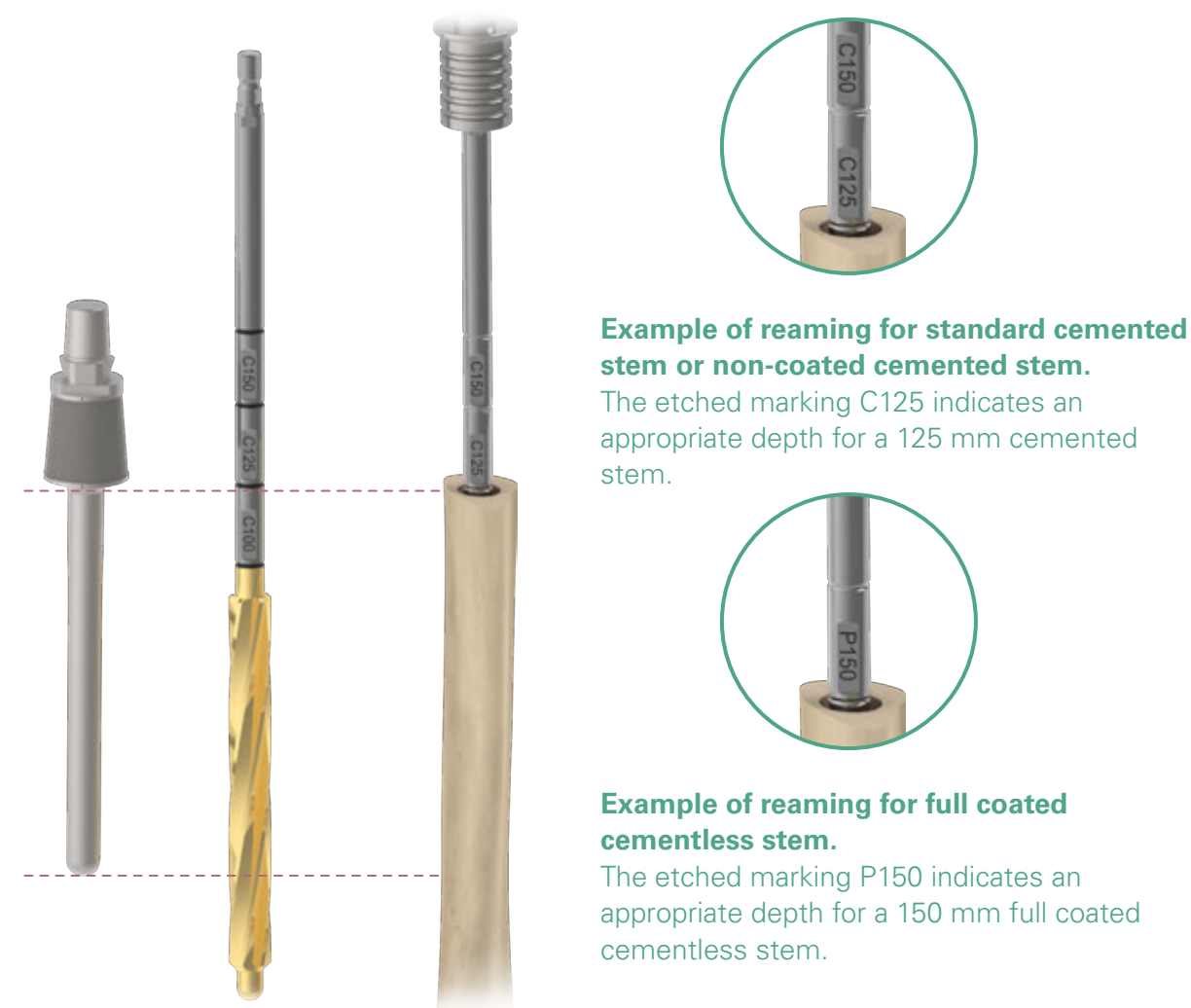

Instruments

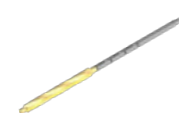

Straight Stem Reamer  
Diameter 8~21 mm

# C.Canal Preparation

Stem Options Reference Chart

	Straight Stem	Curved Stem
Standard Cemented Stem	9 mm diameter x 100 mm Length	9 mm diameter x 125 mm Length
	11 mm diameter x 100 mm Length	11 mm diameter x 125 mm Length
	13 mm diameter x 100 mm Length	13 mm diameter x 125 mm Length
	15 mm diameter x 100 mm Length	15 mm diameter x 125 mm Length
	17 mm diameter x 100 mm Length	17 mm diameter x 125 mm Length
	9 mm diameter x 125 mm Length	9 mm diameter x 150 mm Length
	11 mm diameter x 125 mm Length	11 mm diameter x 150 mm Length
	13 mm diameter x 125 mm Length	13 mm diameter x 150 mm Length
	15 mm diameter x 125 mm Length	15 mm diameter x 150 mm Length
	17 mm diameter x 125 mm Length	17 mm diameter x 150 mm Length
Non-coated Cemented Stem	9 mm diameter x 100 mm Length	9 mm diameter x 125 mm Length
	11 mm diameter x 100 mm Length	11 mm diameter x 125 mm Length
	13 mm diameter x 100 mm Length	13 mm diameter x 125 mm Length
	15 mm diameter x 100 mm Length	15 mm diameter x 125 mm Length
	17 mm diameter x 100 mm Length	17 mm diameter x 125 mm Length
	9 mm diameter x 125 mm Length	9 mm diameter x 150 mm Length
	11 mm diameter x 125 mm Length	11 mm diameter x 150 mm Length
	13 mm diameter x 125 mm Length	13 mm diameter x 150 mm Length
Full-Coated Cementless Stem	N/A	N/A
	11 mm diameter x 150 mm Length	11 mm diameter x 150 mm Length
	13 mm diameter x 150 mm Length	13 mm diameter x 150 mm Length
	15 mm diameter x 150 mm Length	15 mm diameter x 150 mm Length
	17 mm diameter x 150 mm Length	17 mm diameter x 150 mm Length
	N/A	N/A
	11 mm diameter x 200 mm Length	11 mm diameter x 200 mm Length
	13 mm diameter x 200 mm Length	13 mm diameter x 200 mm Length
	15 mm diameter x 200 mm Length	15 mm diameter x 200 mm Length
	17 mm diameter x 200 mm Length	17 mm diameter x 200 mm Length



# C.Canal Preparation

For the standard cemented stem and non-coated cemented stem, connect the **Cemented Stem Barrel Reamer** to the appropriate **Reamer Guide Rod** and advance into the canal to prepare the resected proximal tibia.



Barrel Reamer for Cemented Stem

Instruments



Cemented Stem Barrel Reamer Reamer Guide Rod Diameter 10-21 mm

# C. Canal Preparation

For the cementless stem, connect the **Cementless Stem Barrel Reamer** to the appropriate **Reamer Guide Rod** and advance into the canal to prepare the resected proximal tibia.

Ream to the distal cut-out marking on the barrel reamer. If less than 3 mm of cortical bone around the reamer is observed, stop reaming. The planned implant construct will be 8 mm longer than the original measured plan. The cementless stem will sit above the bone (proud) by 14 mm (8 mm coated and 6 mm non-coated area on the proximal end of stem). The length of the implant construct may be adjusted selecting a shorter segment or making other adjustment.

If there is 3 mm or more of cortical bone around the barrel reamer after the initial reaming step, continue reaming to the proximal cut-out marking on the barrel reamer. The planned implant construct will match the original measured plan. The cementless stem will sit above the bone (proud) by 6mm (6mm non-coated area on the proximal end of the stem). This will be the non-coated area on the proximal end of the stem.

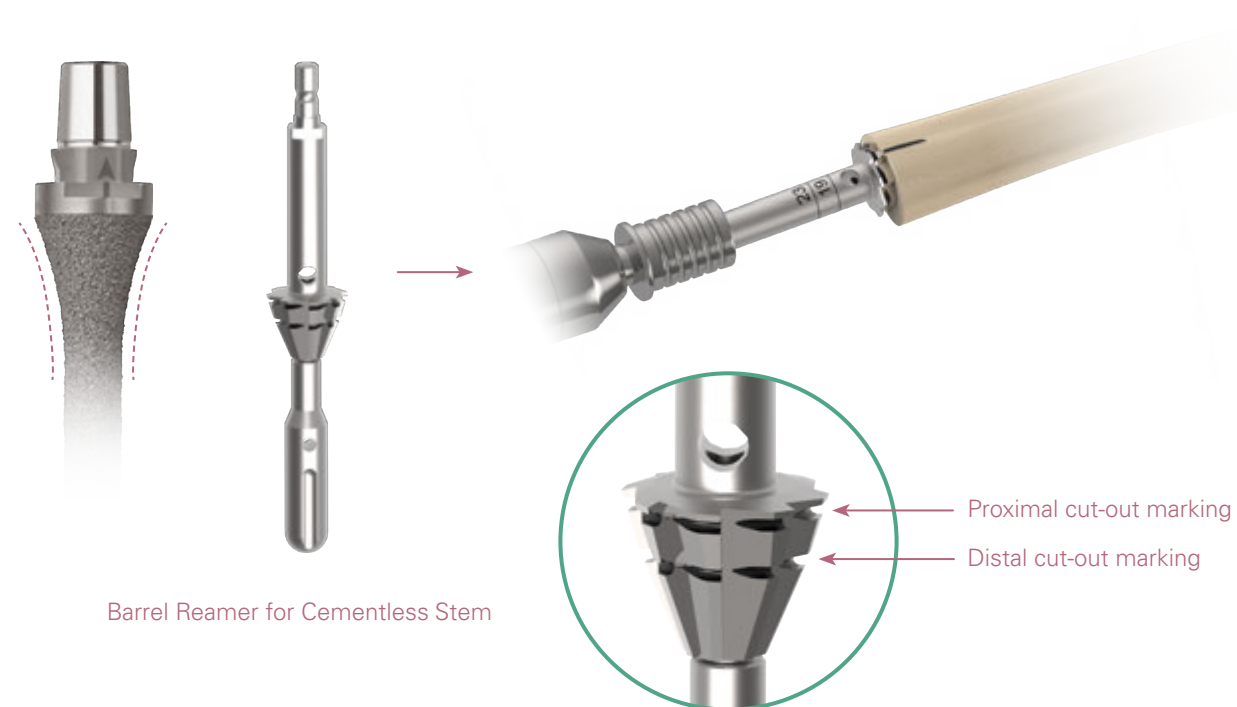

Barrel Reamer for Cementless Stem

Instruments



**Cementless Stem Barrel Reamer**    **Reamer Guide Rod**  
Diameter 10-21 mm

# D. Distal Femoral Resection

Use the **Step Drill** to create an opening into the femoral canal. The drill is inserted to a depth of approximately 100 mm into the femoral canal. This allows for depressurization of the canal when the **IM Rod** is inserted.

Set the **Femoral IM Alignment Guide** to the correct "R" or "L" for right or left knee. Slide the **Femoral IM Alignment Guide** through the **IM Rod** until it is seated against the distal femur. The alignment guide offers a fixed 6 degrees valgus angle.

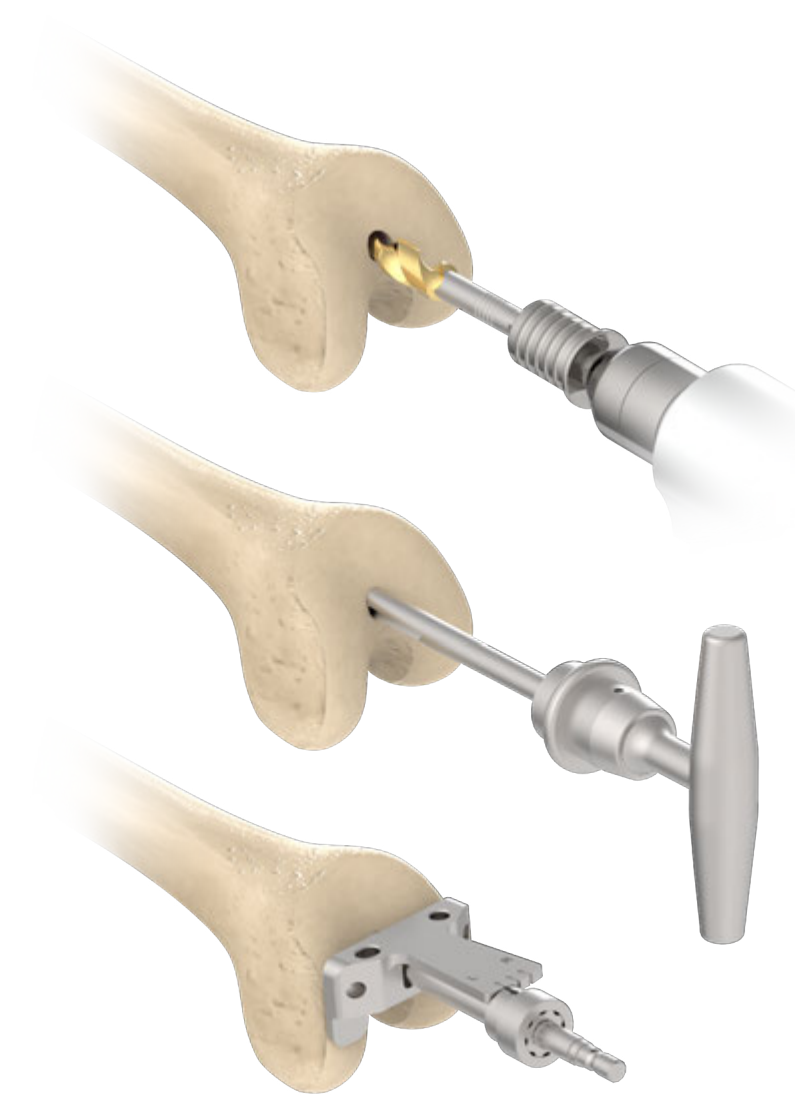

Instruments



**Step Drill**    **Femoral IM Rod**    **Femoral IM Alignment Guide**    **T-Handle**

# D. Distal Femoral Resection

Attach the **Distal Femoral Alignment Guide** and the **Distal Femoral Resection Guide** to the **Femoral IM Alignment Guide**.

Drill pilot holes through the "0" pin holes on the resection guide with the **3.2 mm Drill**, and place a pair of the **Round Pins** to fix the resection guide. Additional **Threaded Pins** may be placed to further secure the resection guide.

Remove the alignment guide assembly, and perform distal femoral resection through the most distal slot on the **Distal Femoral Resection Guide**.

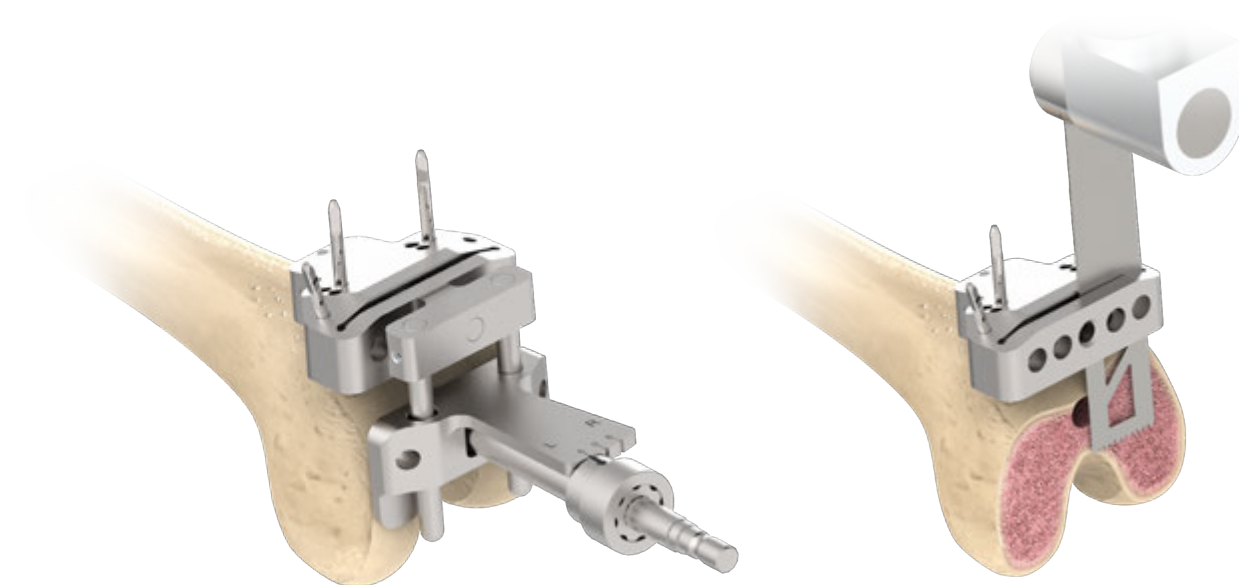

Instruments

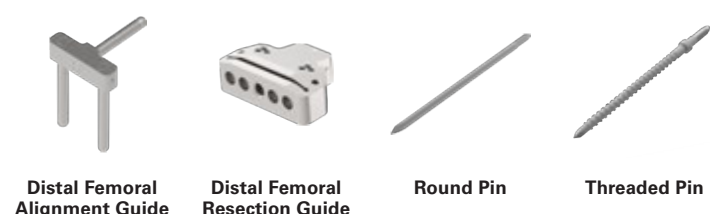

# E. Femoral Canal Preparation

Ream the femoral canal starting with the 9 mm **Femoral Stem Reamer** and progressively increase the diameter until proper cortical contact is achieved at the desired depth. (Reamer options are available from 9mm to 24mm in 1mm increments).

Note the etched markings on the femoral stems, the 'F' indicates the appropriate depth for a femoral component with a stem only with no offset adapter. The 'FA' indicates the appropriate depth for a femoral component with an offset adapter and stem.

**Note:**

- F : Femoral component with the stem
- FA : Femoral component with stem + Adapter

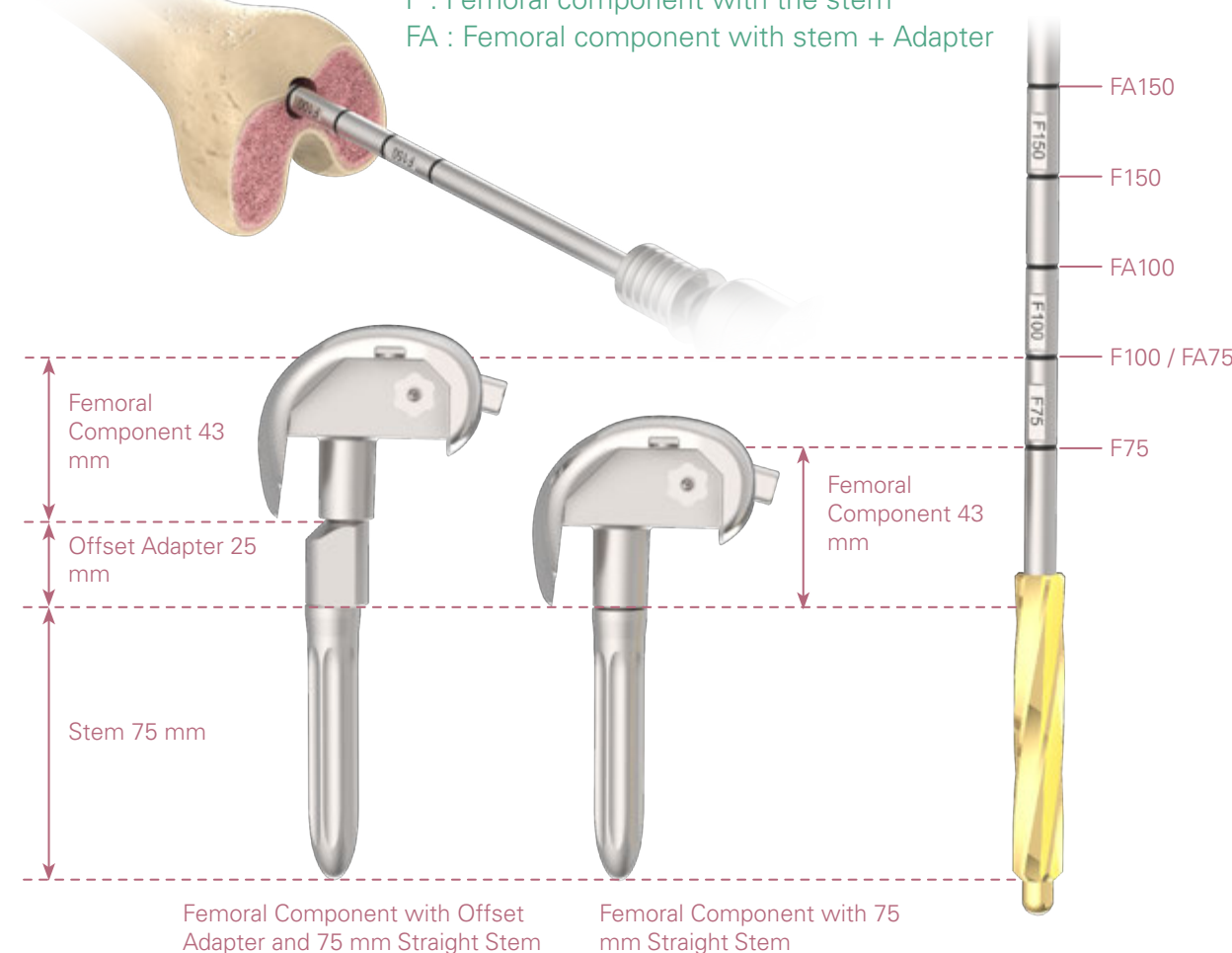

Instruments





# E. Femoral Canal Preparation

Choose the **Reamer Guide Rod** corresponding to the diameter of the last reamer used. Attach the **Reamer Guide Rod** to the **Boss Reamer**.

Ream the femoral canal to the depth until the indicator mark "F" on the **Boss Reamer** lines up with the entry hole. The boss reaming process will not be necessary if the last reamer used is larger than 16 mm.

(Optional) If offset is desired, ream to the indicator mark "FA".

As the reaming process is completed, place the last **Femoral Stem Reamer** in the femoral cavity.

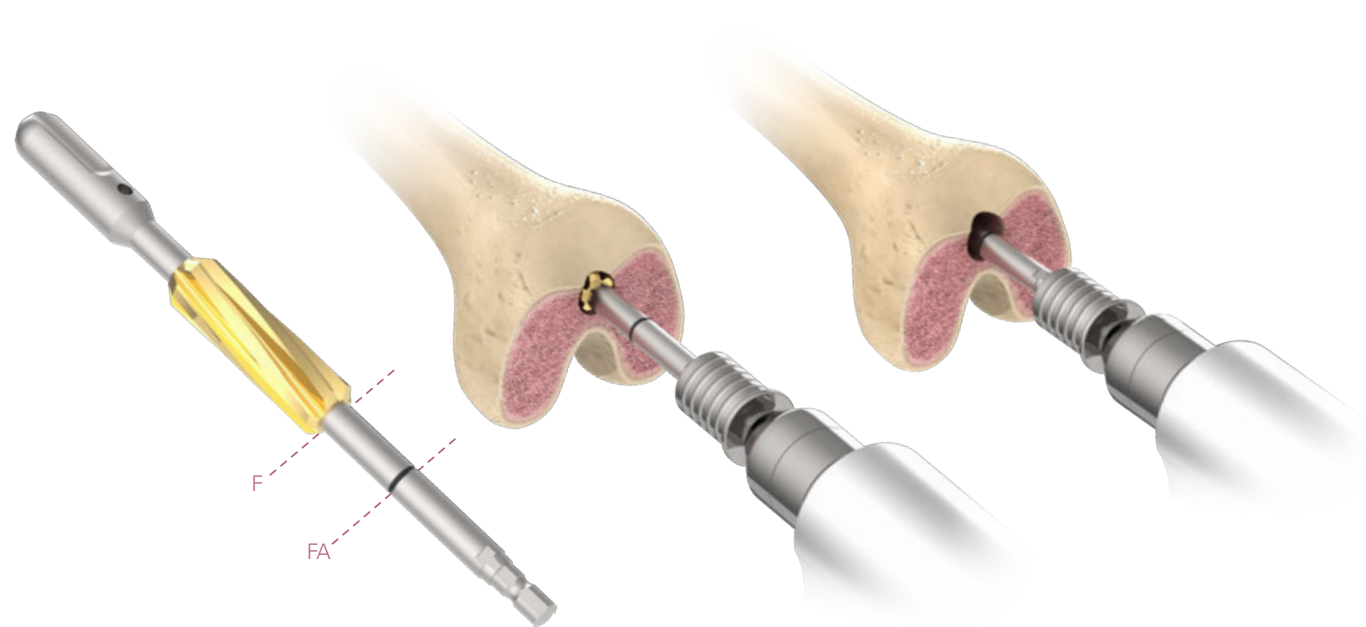

**Note:**  
 Ream to F for non-offset boss preparation  
 Ream to FA if offset is desired after femoral sizing.

Instruments



**Reamer Guide Rod**  
10 / 12 / 14 mm      **Boss Reamer**

# F. Femoral Sizing and Placement

Set the **Femoral Sizer** to the correct "R" or "L" for the patient and lock the external rotation locking knob with the **Screwdriver T20**. This will provide a set 3 degree external rotation. Note. Additional external rotation adjustment can be made at a later technique step.

Place the **Femoral Sizer** through the reamer and onto the resected distal femur surface with the posterior feet of the Femoral Sizer seated on the posterior condyles.

Position the stylus tip to contact the lowest point of the anterior femoral cortex. Confirm the optimal femoral component size based on the sizing options from the main panel of the **Femoral Sizer**.

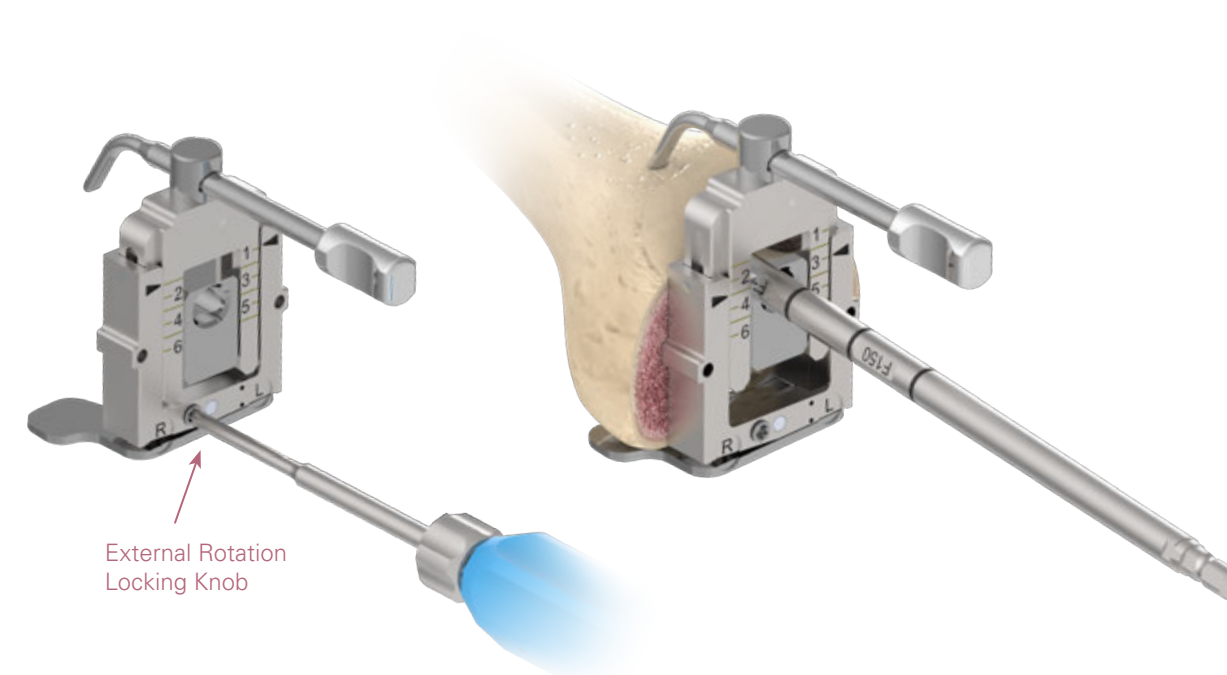

External Rotation Locking Knob

Instruments



**Femoral Sizer**      **Driver Handle**      **Screwdriver Adapter T20**



# F.Femoral Sizing and Placement

## F1. Optional A/P Offset Evaluation with Set 3 Degrees External Rotation

Determine preliminary A/P offset by attaching the **Femoral Offset Blade** that corresponds to the selected femoral size over the **Femoral Sizer** with the semi-circle cutout aligned with the reamer.

Note the offset marking adjacent to the gap between the posterior feet and the markings on the body of the **Femoral Sizer**. This will give a rough estimate of the A-P offset needed.

If no further M/L offset or external rotation adjustment is needed, make a pair of pilot holes through the pin holes on the **Femoral Sizer**. These pilot holes will be used to position the **Femoral A/P Chamfer Cutting Guide**.

Remove the sizer assembly.

### Example of Setting 4mm Posterior Offset.

if the gap on the posterior feet aligns with the -4 slot of the blade, this will represent the component is offset by 4 mm posterior.

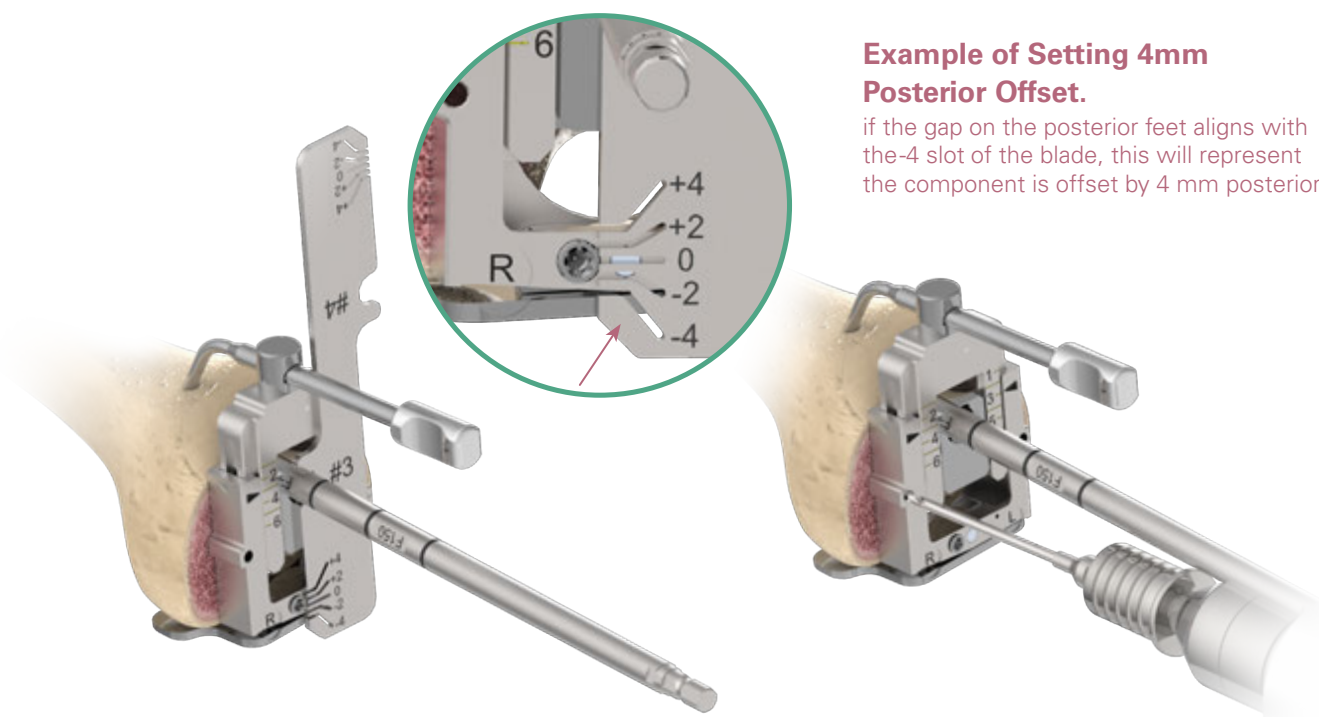

Instruments

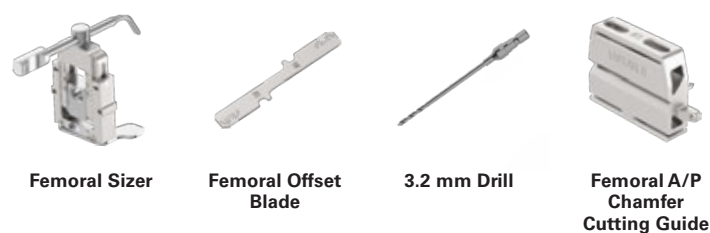

# F.Femoral Sizing and Placement

## F2. Optional Femoral Offset Evaluation and with Adjustable External Rotation

To further evaluate external rotation adjustment or offset adjustment, assemble the selected size **Femoral Offset Template**, the selected size **Femoral Valgus Offset Adapter** ( 2/4/6 mm, Left or Right ), **Stem Trial** together with **Screwdriver T20**.

Position the **Femoral Offset Template** assembly on the resected distal femoral surface. Evaluate offset level, implant coverage and external rotation with the **Femoral Offset Template**. Adjust the Offset Orientation knob using the **Screwdriver T20**.

The projected A/P bone resection can be evaluated by inserting the **Resection Check Blade** into the resection slots.

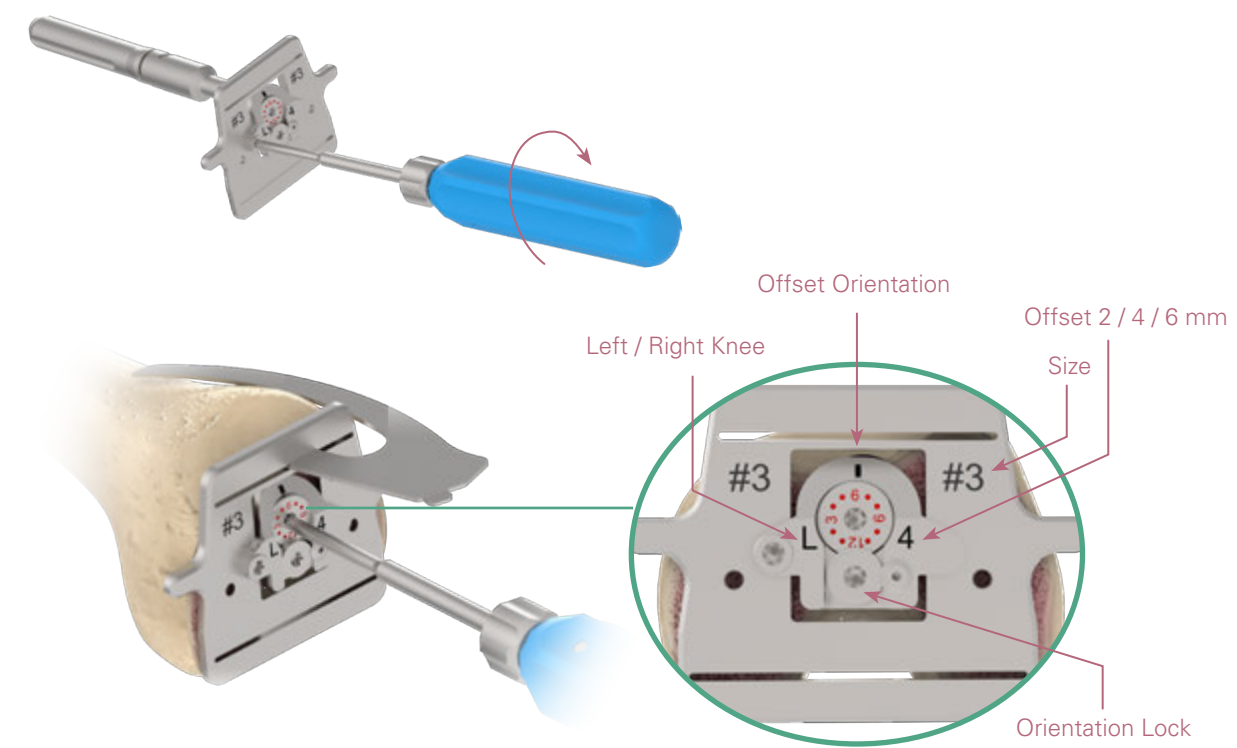

Instruments

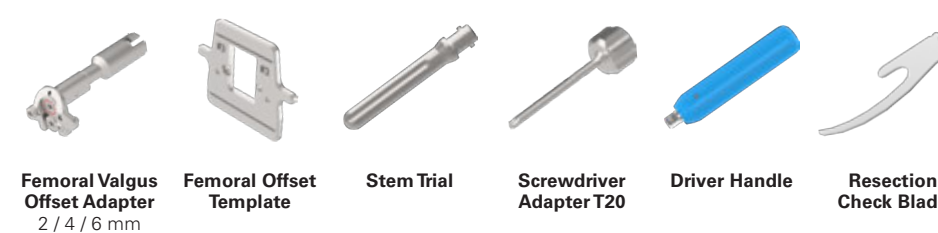

# F.Femoral Sizing and Placement

## F2. Optional Femoral Offset Evaluation and with Adjustable External Rotation

Once the ideal offset position is set, lock the offset knob with the **Screwdriver T20**.

Make a pair of pilot holes through the pin holes on the **Femoral Offset Template** with the **3.2 mm Drill**. These pilot holes will be used to position the **Femoral A/P Chamfer Cutting Guide**.

Remove the **Femoral Offset Template** assembly.

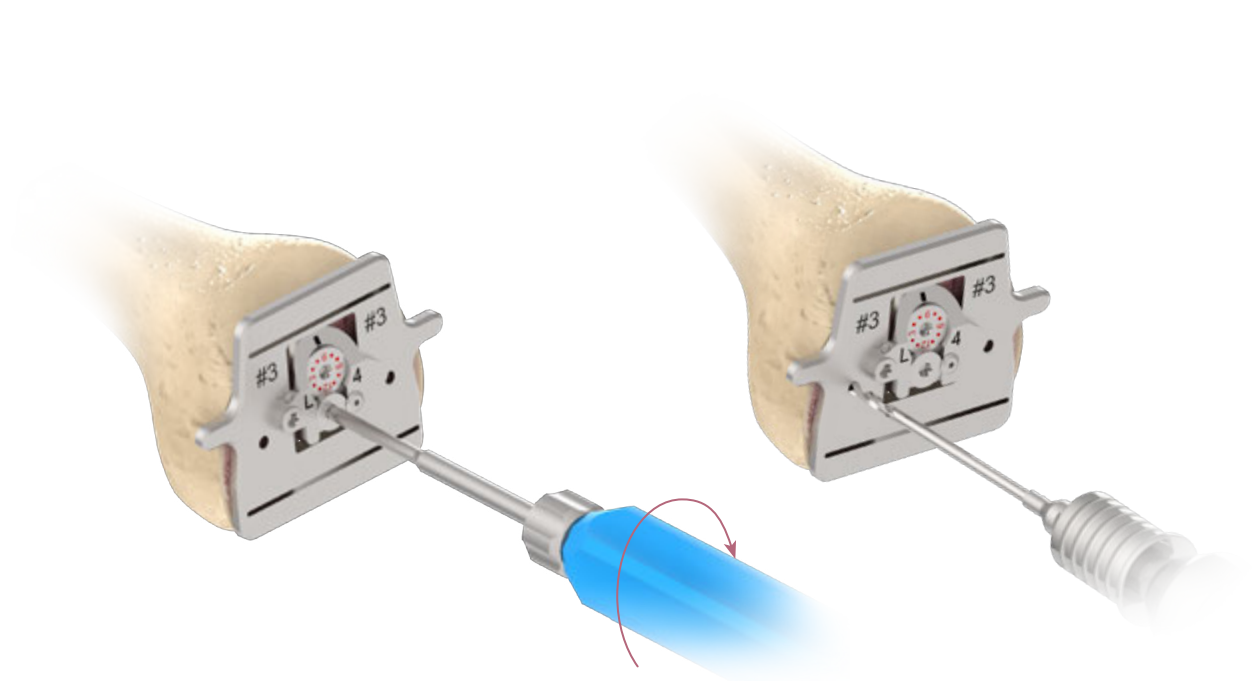

Instruments

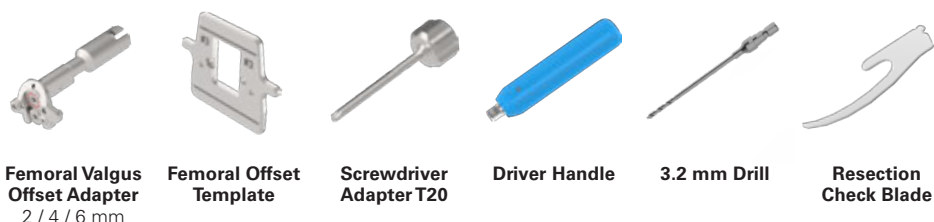

# F.Femoral Sizing and Placement

Place the **Femoral A/P Chamfer Cutting Guide** into the pre-drilled pin holes.

Secure the cutting guide with **Threaded Pins** and complete the A/P and chamfer resections.

Remove the **Femoral A/P Chamfer Cutting Guide**.

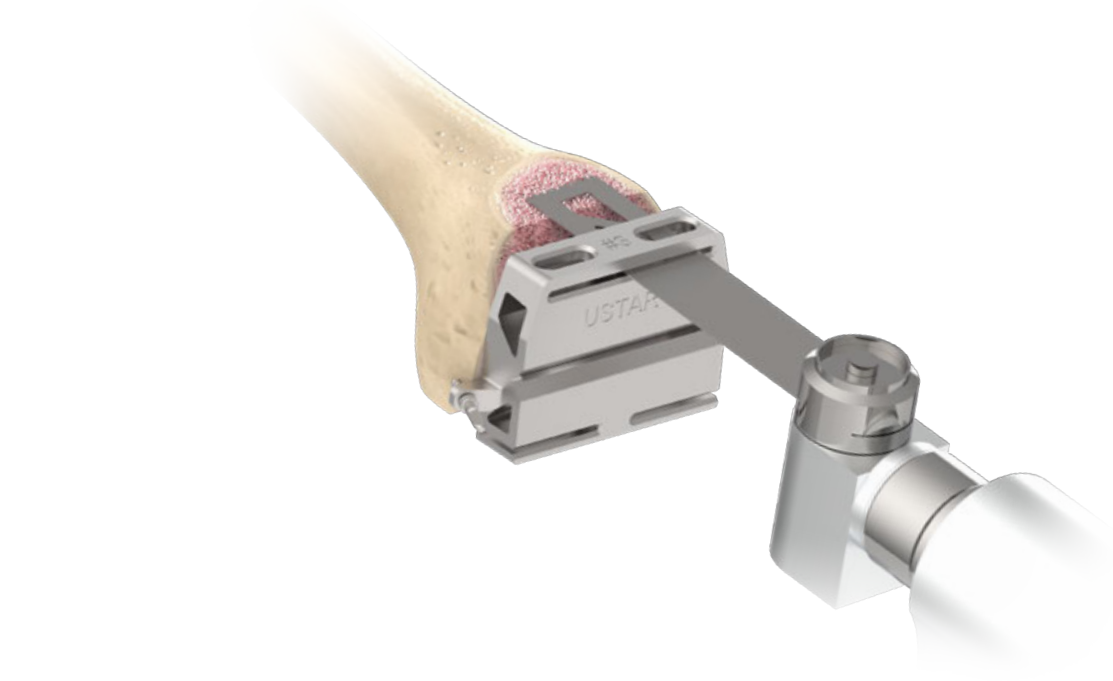

Instruments

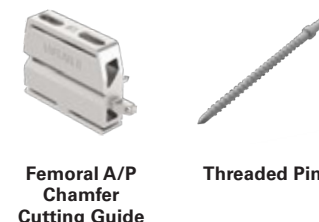

# G.Femoral Box Preparation

Assemble the selected size of the **Femoral Sizing Template, Valgus offset Adapter, Stem Trial** together with **Screwdriver Adapter T20**.

Secure the **Femoral Sizing Template** assembly with **Round Pins** in the anterior holes.

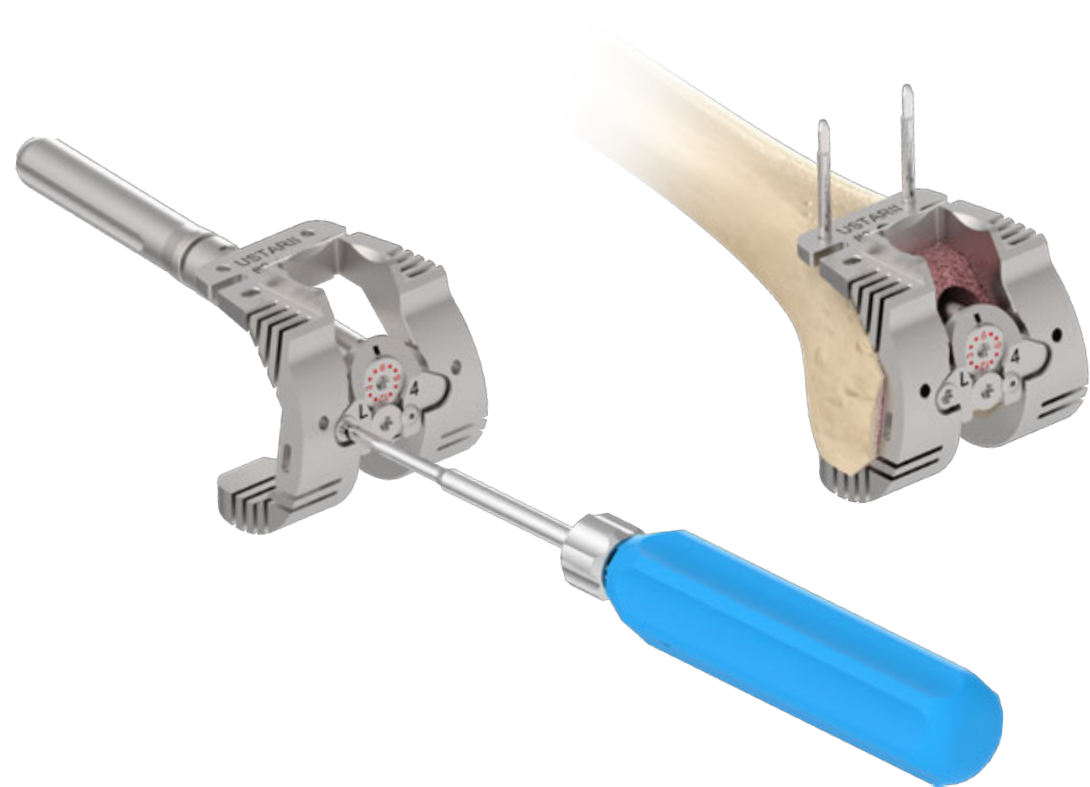

Instruments

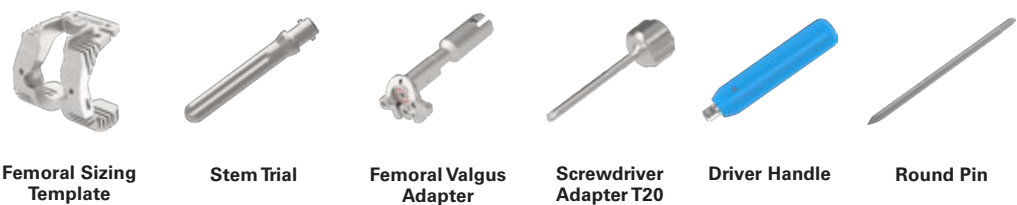

Femoral Sizing Template   Stem Trial   Femoral Valgus Adapter   Screwdriver Adapter T20   Driver Handle   Round Pin

# G.Femoral Box Preparation

Disassemble the **Femoral Valgus Adapter** and the **Femoral Sizing Template** with the screwdriver. Use the **Valgus Adapter Remover** to remove the **Femoral Valgus Adapter** and the **Stem Trial**.

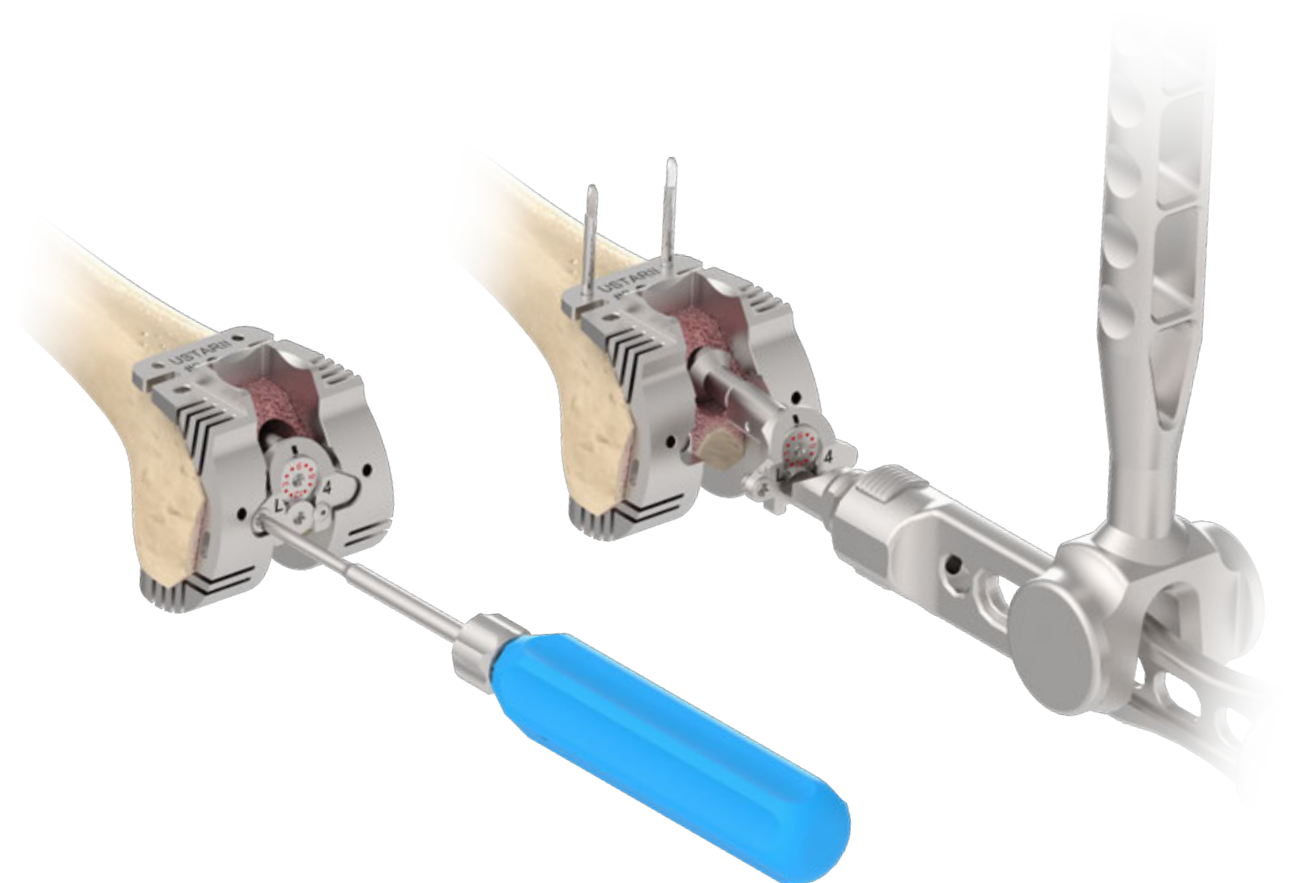

Instruments



Screwdriver Adapter T20   Driver Handle   Valgus Adapter Remover   Modular Handle

# G.Femoral Box Preparation

If offset is desired, secure the **Femoral Sizing Template** with two **Round Pins** on resected distal femoral surface.

Assemble the **Femoral Offset Drill Guide** onto the **Femoral Sizing Template** with the **Screwdriver T20**.

Drill through the **Femoral Offset Drill Guide** with the **Femoral Offset Boss Drill** until fully engaged.

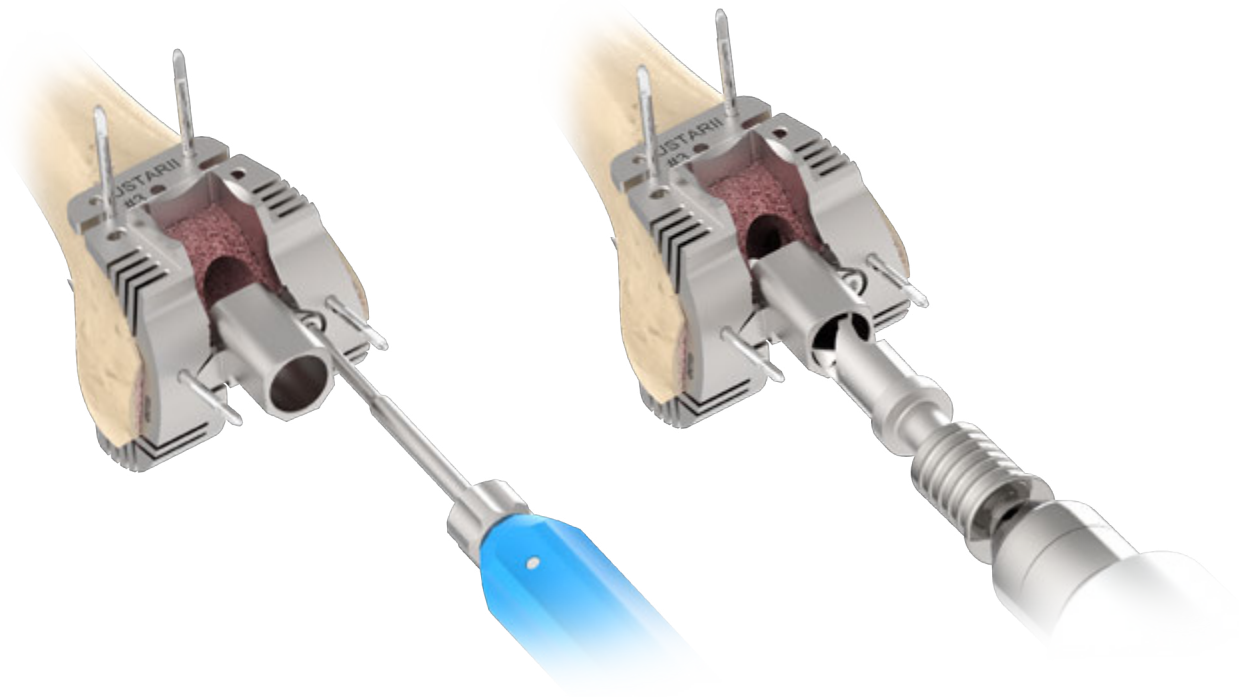

Instruments



Femoral Offset Drill Guide    Screwdriver Adapter T20    Driver Handle    Femoral Offset Boss Drill    Femoral Sizing Template

# G.Femoral Box Preparation

Assemble the **Box Cutting Guide** to the **Femoral Sizing Template** with the **Screwdriver**.

Using a standard 1.27 mm saw blade, complete a parallel bone resection through the posterior cortex.

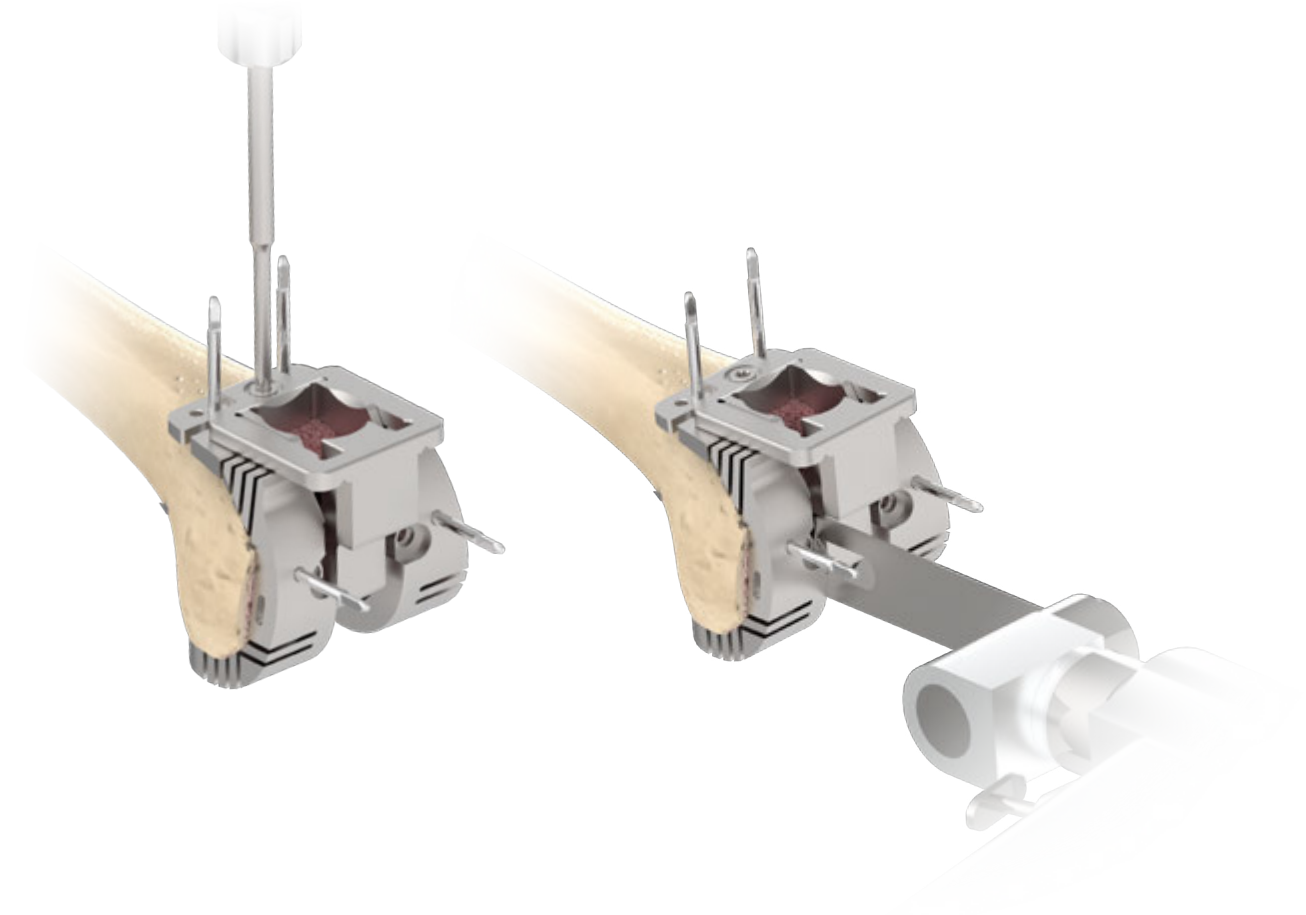

Instruments

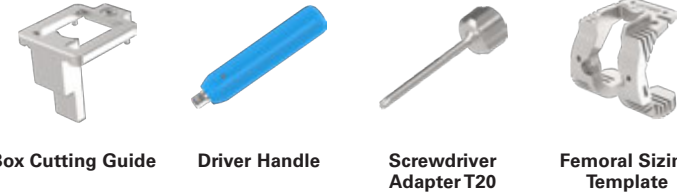

Box Cutting Guide    Driver Handle    Screwdriver Adapter T20    Femoral Sizing Template



# G. Femoral Box Preparation

Using the **Box Reamer**, ream through **Box Cutting Guide** until the stop is fully engaged and in contact with the top surface of the guide.

Using the **Box Chisel**, impact through the **Box Cutting Guide** to ensure the corners of the box housing are 'square'.

Remove the **Femoral Sizing Template/Box Cutting Guide** assembly.

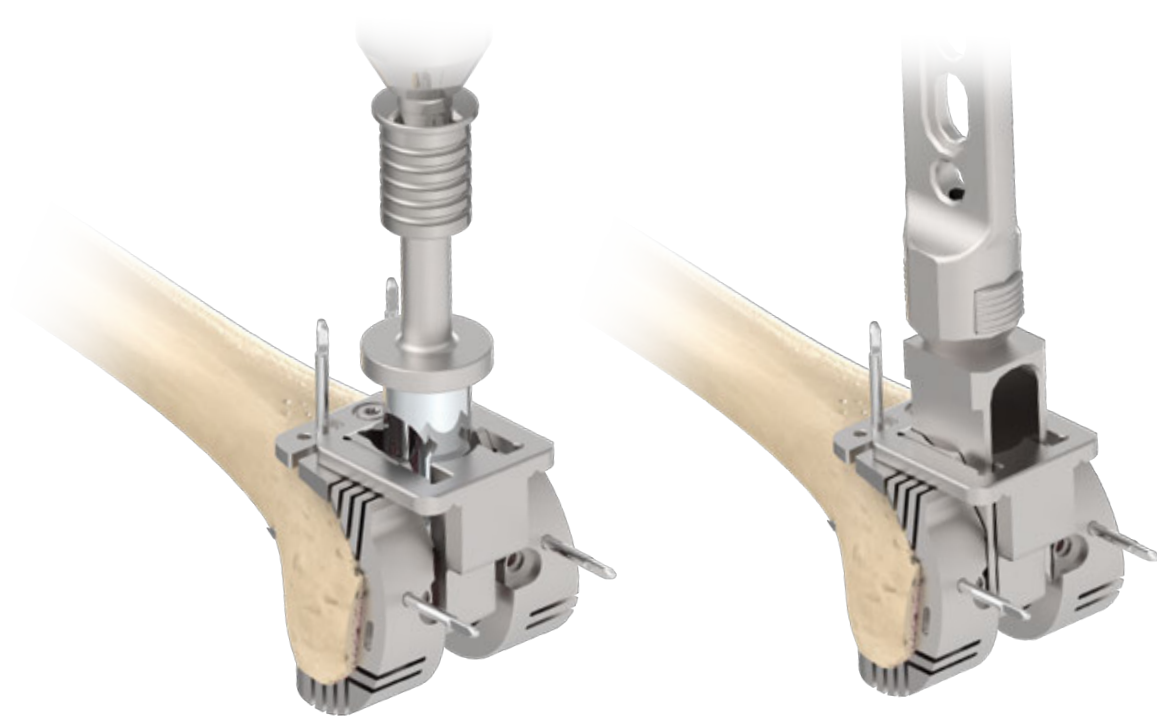

Instruments



Modular Handle    Box Chisel    Femoral Sizing Template    Box Cutting Guide    Box Reamer #1~#3 #4~6

# H. Trialing

Assemble the **Femoral Trial**, the **Offset Adapter Trial** if needed, and the **Stem Trial**.

If using the **Offset Adapter Trial**, use the **Screwdriver** to prepare the **Offset Adapter Trial** by unlock the knob on the top of the instrument.

Align the indicator on the **Offset Adapter Trial** to the predetermined offset number, then lock the knob.

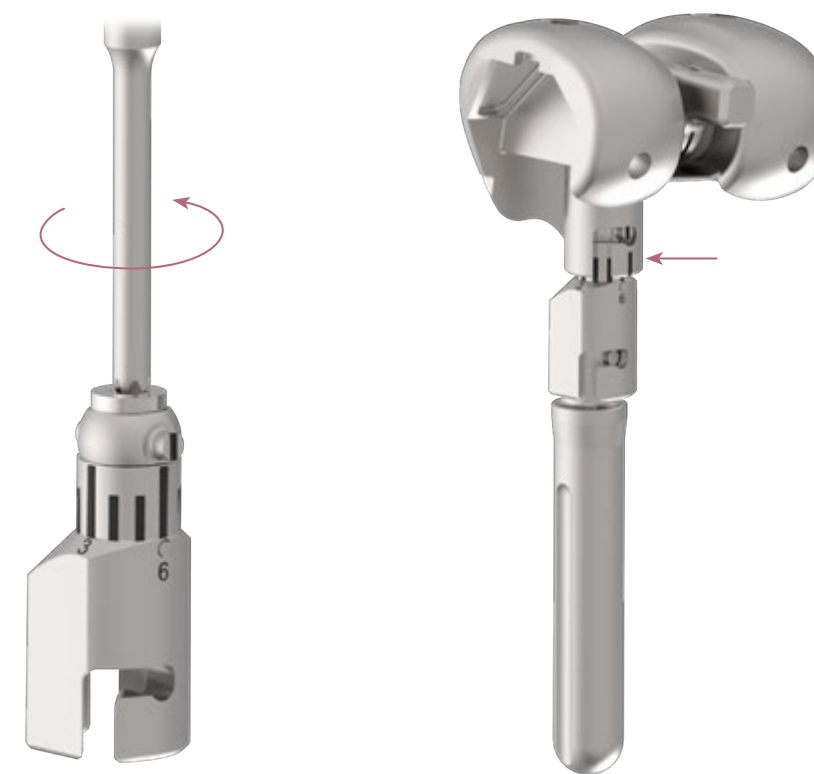

Instruments



Offset Adapter Trial 2 / 4 / 6 mm    Femoral Trial    Stem Trial    Driver Handle    Screwdriver Adapter T20

# H. Trialing

Place the femoral trial assembly onto the prepared femoral surface using the **Femoral Driver**.

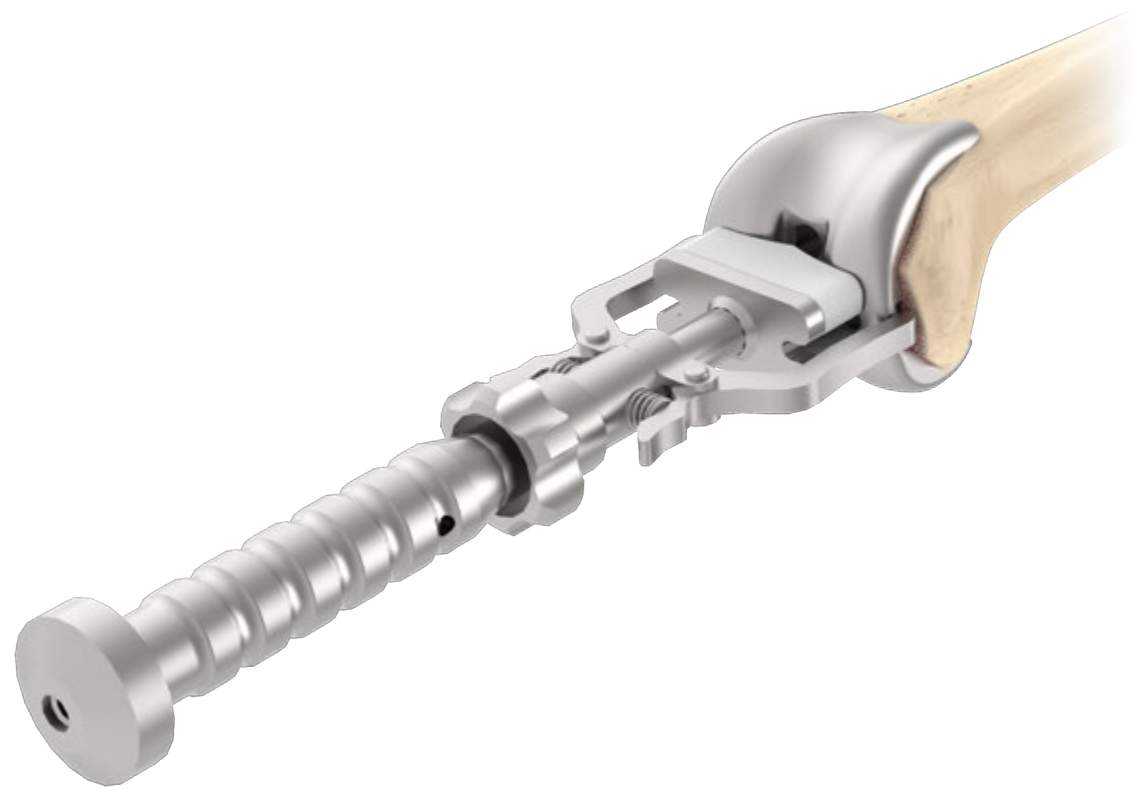

Instruments



Femoral Driver

# H. Trialing

Choose the **Stem Trial Body** and **Stem Trial Adapter** that corresponds to selected cemented or cementless stem size.

Attach the **Stem Trial Body** into the **Stem Trial Adapter** (see image part 1 and 2, the anterior indicators shall align together).

Insert the **Screwdriver Adapter T30** into the top of the **Stem Trial Adapter** and secure with the **Driver Handle** (see image part 3).

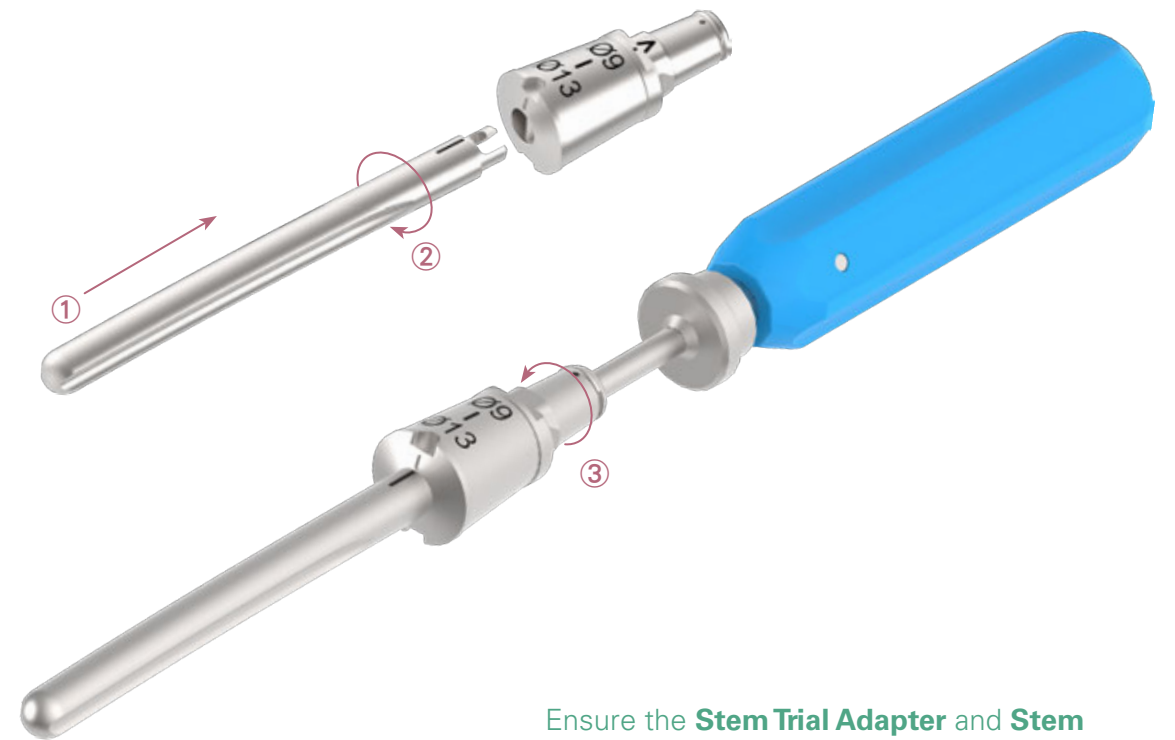

Ensure the **Stem Trial Adapter** and **Stem Trial Body** are fully attached and locked into position prior to trialing.

Instruments



**Cemented Stem Trial Body**  
Diameter 9~17 mm  
**Cemented Stem Trial Adapter**  
Diameter 9~13 mm  
Diameter 15~19 mm  
**Cementless Stem Trial Body**  
Diameter 11~17 mm  
**Cementless Stem Trial Adapter**  
Diameter 11~17 mm  
**Driver Handle**  
**Screwdriver Adapter, T30**



# H. Trialing

Identify the correct length **Segment Trial** to restore tibial length using the chart below. During trialing, multiple trial segments may be combined to represent the ideal monolithic implant assembly length.

Attach the selected **Segment Trial** component(s) to the selected **Proximal Tibial Trial**. Attach the **Proximal Tibial Trial/Segment Trial** assembly to the **Stem Trial Adapter/Stem Trial Body** assembly.

**Segment Trial Reference Chart**

Segment (mm)	Segment Trial (mm)
25	25
30	30
40	40
50	50
60	60
70	70
80	30 + 50
90	40 + 50
100	40 + 60
110	110
120	50 + 70
130	60 + 70
140	30 + 110
150	150
160	50 + 110
170	60 + 110
180	70 + 110
190	40 + 150
200	50 + 150
210	60 + 150
220	70 + 150

Combining shorter Segment Part Trials to mimic longer length of segments



# H. Trialing

Insert the selected **Yoke Adapter S** onto the the **Proximal Tibial Trial**.

Connect the **Yoke Adapter** and the femoral assembly.

Attach the selected **Tibial Insert Trial** to the **Tibial Insert Trial Handle** and connect to the **Yoke Adapter** on the tibial assembly.

Evaluate joint stability using the selected trial components. Switch to different **Tibial Insert Trial** thicknesses as needed to obtain optimal stability.



**Instruments**



**Segment Trial** 25~150 mm  
**Proximal Tibial Trial** Left/Right  
**Cemented Stem Trial Body** Diameter 9~17 mm  
**Cemented Stem Trial Adapter** Diameter 9~13 mm  
**Cementless Stem Trial Body** Diameter 11~17 mm  
**Cementless Stem Trial Adapter** Diameter 11~17 mm

**Instruments**



**Tibial Insert Trial**  
**Tibial Insert Trial Handle**  
**Yoke Adapter S**

# H. Trialing (Removal)

Remove the femoral trial assembly with the **Femoral Driver**.

Position the **Taper Separator** to the junction between the trial components to separate apart by levering the trials.

If it is difficult to remove the stem trial assembly manually, remove the stem trial by connecting the **Stem Trial Remover** to the end of the trunnion. Utilize the **Slotted Hammer** remove the stem trial if needed.



Instruments



Femoral Driver Taper Separator Modular Handle Stem Trial Remover

# I. Implant Assembly

Place the selected femoral component onto the **Distal Femur Impactor Base**.

If selected, connect the femoral component with the correct offset adapter by tapping the prosthesis with the **Stem Impactor** in position. To position the offset into proper orientation, seat the **Stop Tube** on the femoral component and place the **Femoral Offset Fixture** over the **Stop Tube**. Utilize the **Femoral Offset Wrench** to set the offset adapter match the direction of the trial assembly.



Instruments



Distal Femur Impactor Base Stop Tube Femoral Offset Fixture Femoral Offset Wrench

# I. Implant Assembly

Connect the selected extension stem to the femoral component assembly by tapping the stem with the **Stem Impactor** in position.

Thread the femoral screw into the intercondylar hole to secure the assembly.

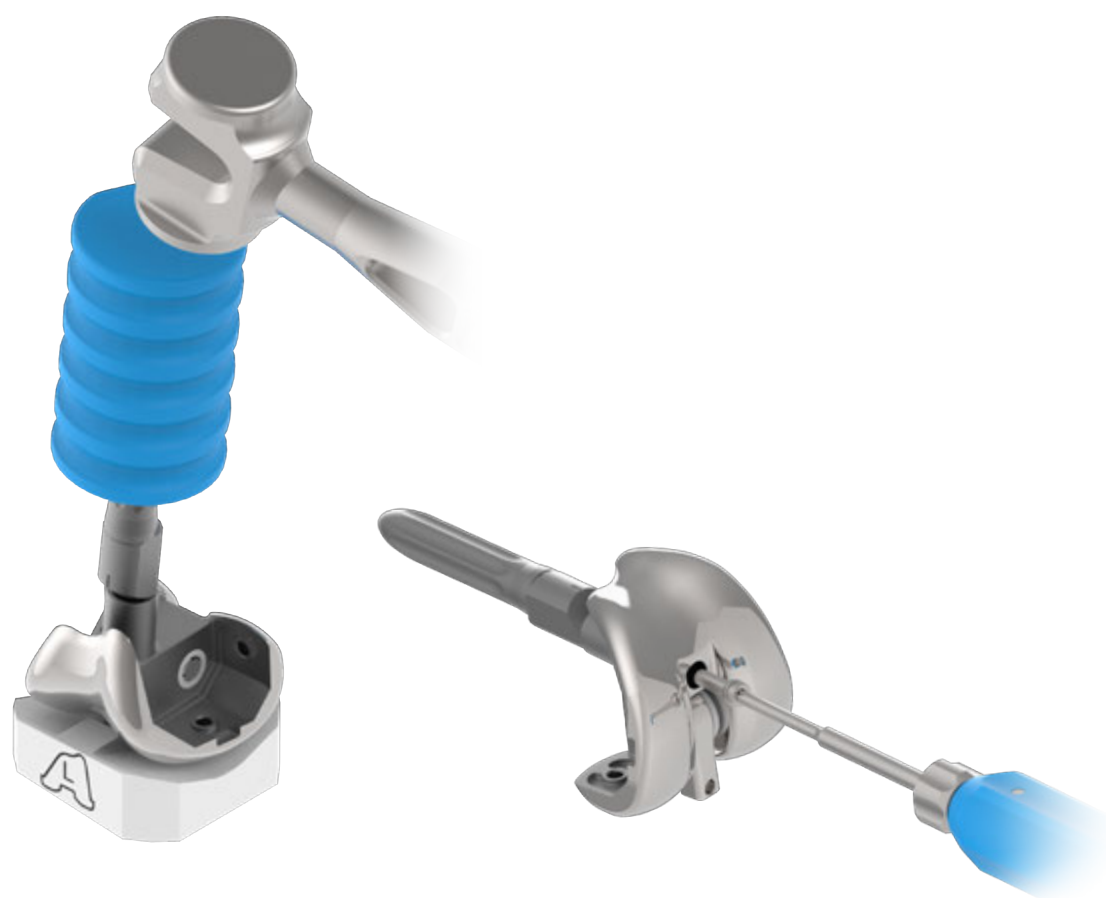

Instruments



Stem Impactor    Driver Handle    Screwdriver Adapter T20

# I. Implant Assembly

Assemble the implants starting with proximal tibial component and the segment (if selected), then the selected stem.

Place the selected proximal tibial component onto the **Proximal Tibial Impactor Base**. Verify the medial and lateral set screws are not obstructing the taper recess, loosening the set screws if needed.

Connect the proximal tibial component with the correct segment component by aligning the anterior mark and tapping the prosthesis with the **Stem Impactor** in position.

Confirm the medial and lateral set screws on the segment is not obstructing the taper recess. Connect the selected stem component to the tibial component/segment assembly by aligning the anterior mark and tapping the prosthesis with the **Stem Impactor** in position.

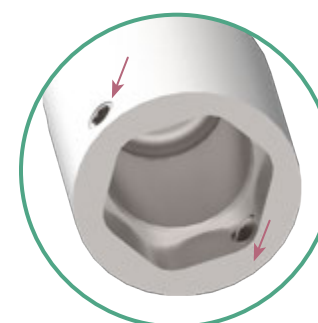

Always verify the medial and lateral set screws are not obstructing the taper recess before tapping the assembly together. Obstruction of the set screws inside the taper recess may result in an unsuccessful connection. The **Set Screw Driver Adapter** can be used to retract the set screw.



Instruments



Proximal Tibial Impactor Base    Stem Impactor    Slotted Hammer    Set Screw Driver Adapter

# I. Implant Assembly

Connect the **Set Screw Torque Limiter** to the **Driver Handle** and tighten the medial and lateral set screws. The **Set Screw Torque Limiter** is used to ensure an appropriate amount of torque is applied to prevent over-tightening.

Note :  
Do not use the **Torque Limiter** to loosen a set screw if this is required.

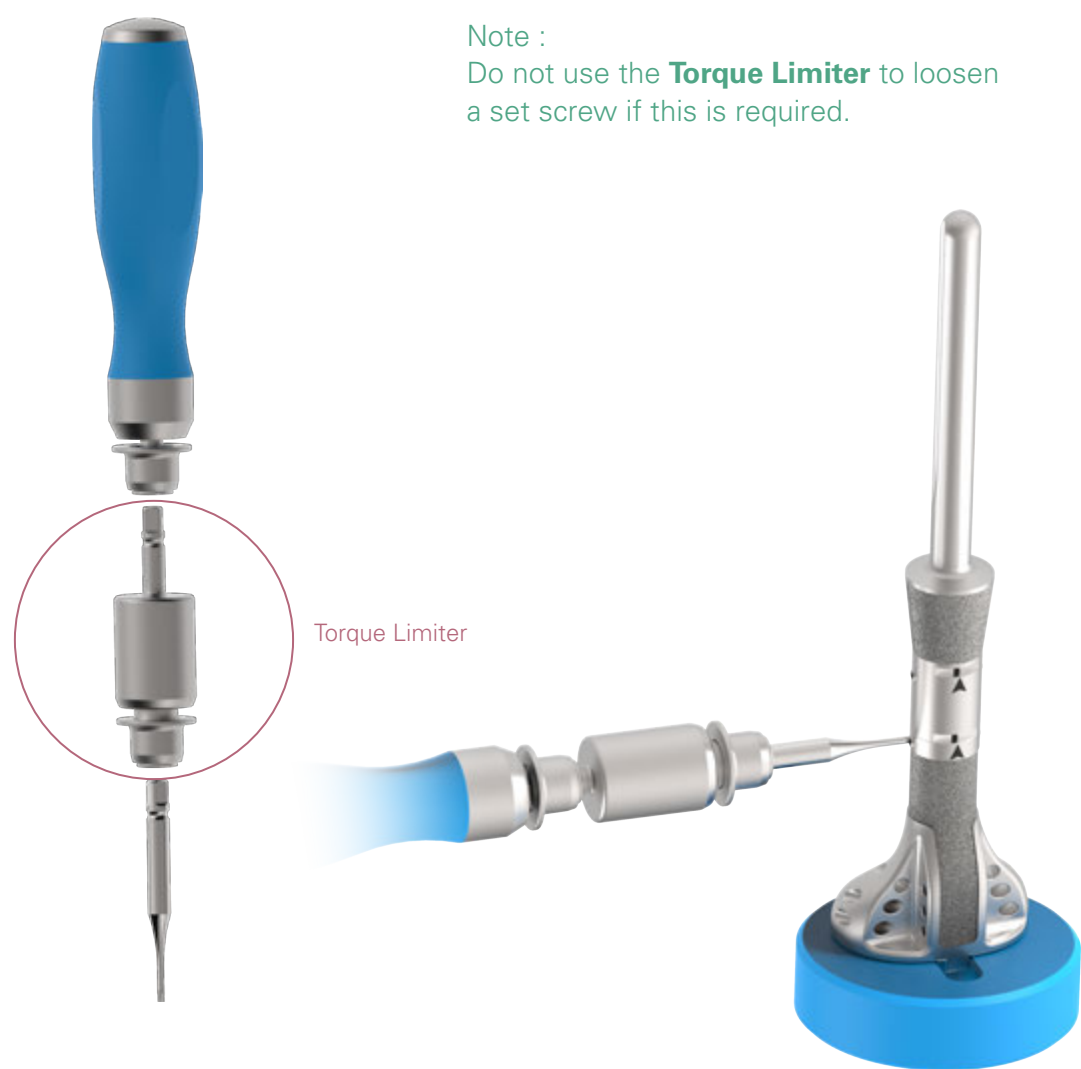

Torque Limiter

Instruments



Set Screw Driver Adapter    Set Screw Torque Limiter    Driver Handle

# J. Implantation

If a cemented stem is selected for the tibial construct, use the **Cement Restrictor Inserter** to introduce the selected cement restrictor to an adequate depth in the canal. Use the indicators on the shaft to set the depth.



The etched marking **C125** indicates the appropriate depth of the 125 mm cemented stem.

Use the cement restrictor that is one size smaller than the diameter of the last reamer used to allow smooth insertion.

Cement Restrictor, I-Type		
Cat. No.	Size	Canal size (mm)
1907-1008	# 8	8 - 9
1907-1010	# 10	10 - 11
1907-1012	# 12	12 - 13
1907-1014	# 14	14 - 15
1907-1016	# 16	16 - 17
1907-1018	# 18	18 - 19

Instruments



Cement Restrictor Inserter

# J. Implantation

Fill the tibial canal and around the tibial implant assembly with cement.

Advance the tibial prosthesis assembly into the canal manually until fully seated onto the prepared bone surface. Attach the **Tibial Baseplate Impactor** to the **Modular Handle** and impact if needed.

Rotational alignment may be set by referencing the mark previously made on the anterior cortex of the tibia.



Instruments



Tibial Baseplate Impactor    Modular Handle

# J. Implantation

Apply bone cement to distal femoral resection and the proximal surface of the femoral component.

Place the implant assembly onto the prepared femoral surface with **Femoral Driver**. Attach the **Femoral Impactor** to the **Modular Handle** and impact the femoral component assembly until fully seated and in proper contact with the bone.

Remove the plastic protective cover on the femoral component after clean out the excessive cement.



Instruments



Femoral Driver    Femoral Impactor    Modular Handle



# J. Implantation

Perform a final check to confirm the optimal tibial insert thickness with the last **Tibial Insert Trial**. Insert using the **Tibial Insert Handle** as described in previous steps.



Instruments



Tibial Insert Trial Tibial Insert Trial Handle

# J. Implantation

With the knee in flexion, place the selected tibial insert onto the implanted tibial construct assembly, making sure to maintain alignment with the hinge post of the femoral component.

With the knee in full extension, secure the tibial insert to the femoral prosthesis by tightening the built-in set screw inside the tibial insert with **Insert Set Screwdriver** to apply appropriate fixation torque.

Tighten the set screw until fully connected within the femoral component, confirming with the depth mark on the screwdriver.



Align the **depth mark S** on the screwdriver for the **size #S** tibial insert.

If the depth mark is achieved but the torque limiter has not engaged, continue apply torque until engaged;  
If the torque limiter is engaged before the depth mark is achieved, then the screw may not be correctly connected to the femoral component. Confirm the femoral assembly is fully seated in the tibial insert, then re-tighten the set screw.

Instruments



Insert Set Screwdriver

# Appendix I:

## Taper Disassembly

If there is a need to disassemble the taper junction for any reason, connect the **Driver Handle** to the **Set Screw Adapter** and release the set screws on both sides of the component or segment.

If needed, place the **Taper Separator** on the component and gently tap with a **Slotted Hammer** to separate the assembly.

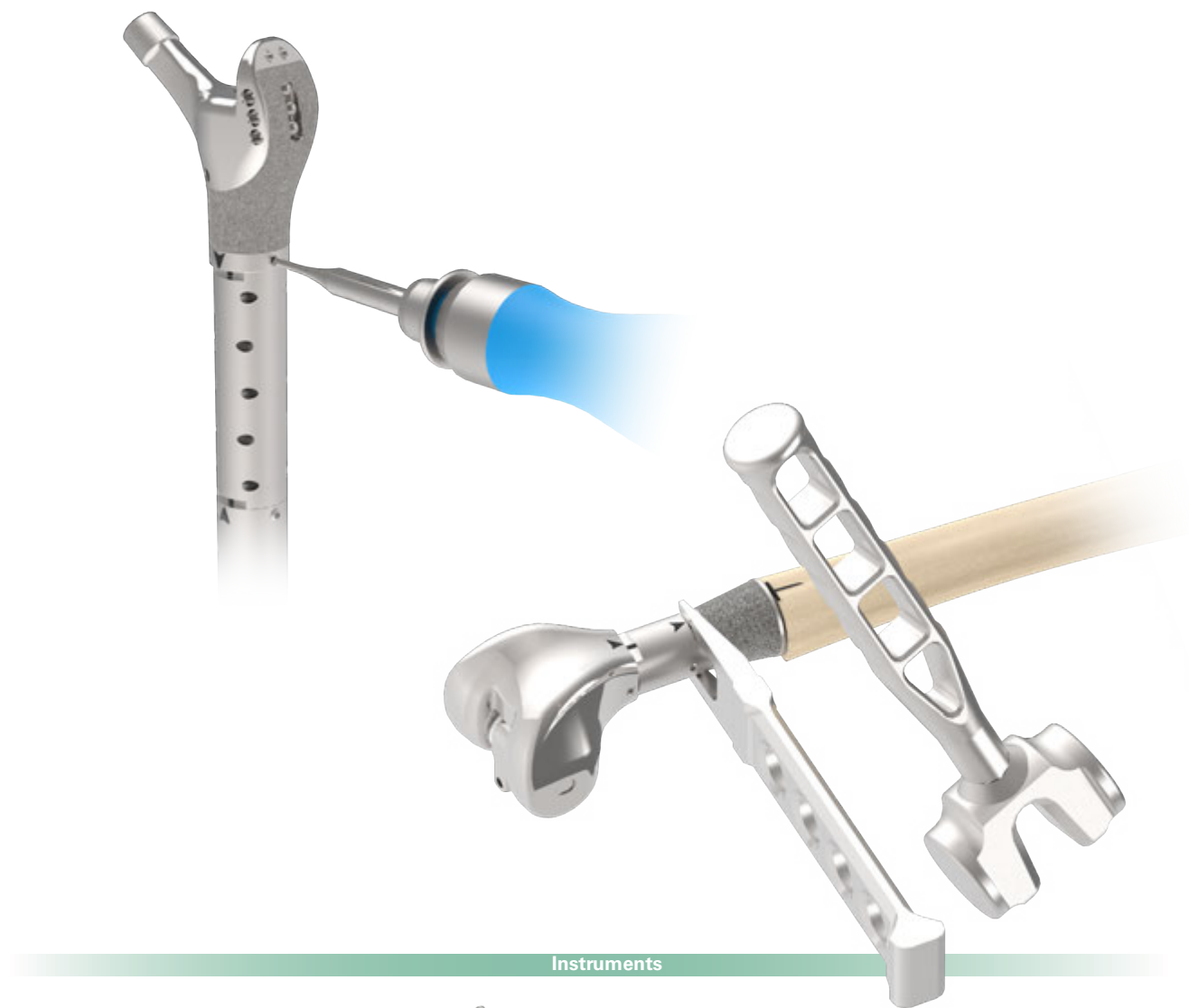

Instruments



Set Screw  
Driver Adapter

Driver Handle

Taper Separator

Slotted Hammer

# Appendix II. Distal Femoral Assembly XS

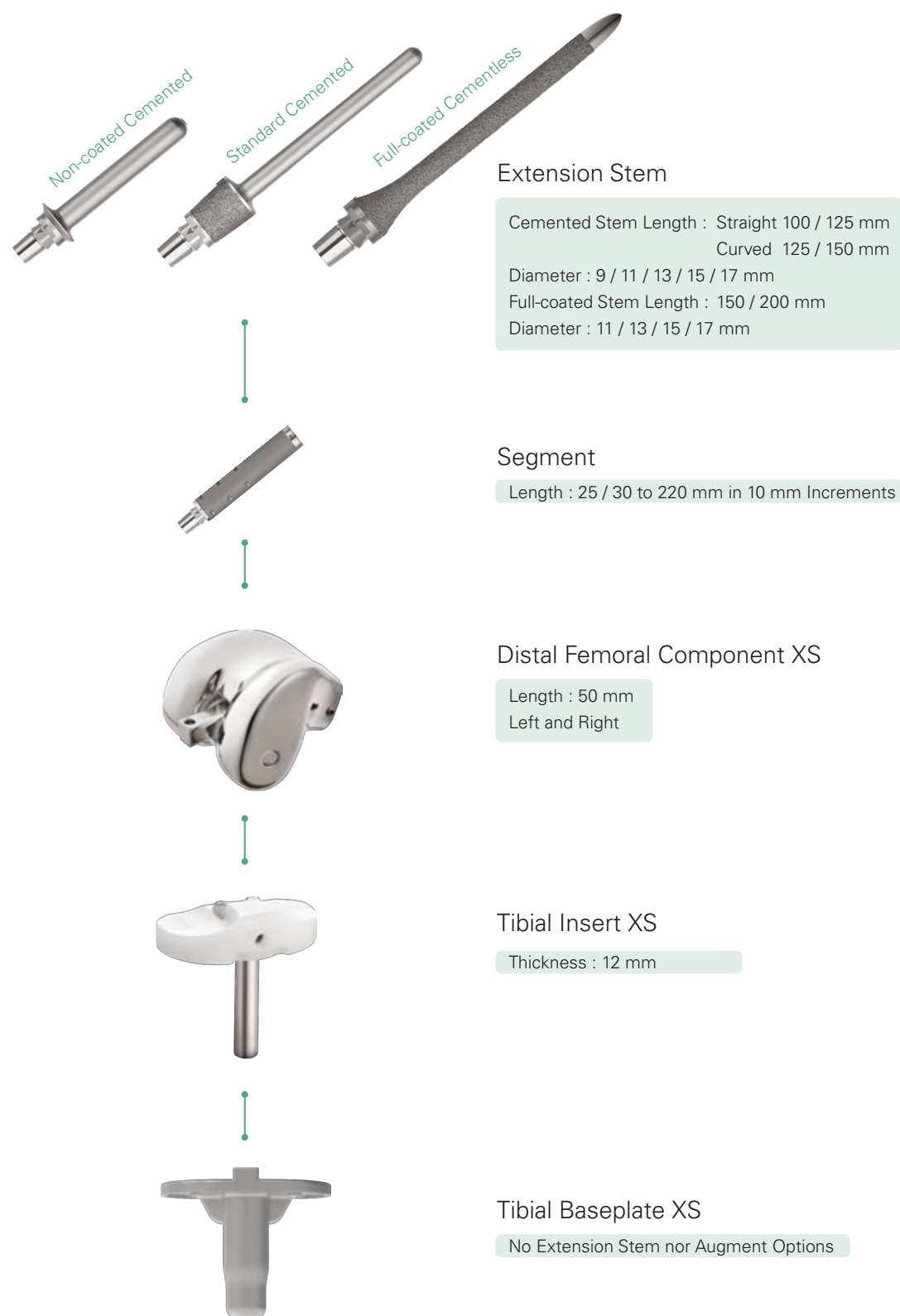

# Appendix II :

The length for size XS Distal femoral components is 50 mm, 5 mm less than standard resection. XS components accept regular segment and stem options.

The thickness of the XS insert and baseplate is 12 mm. No extension stem and augment are allowed.

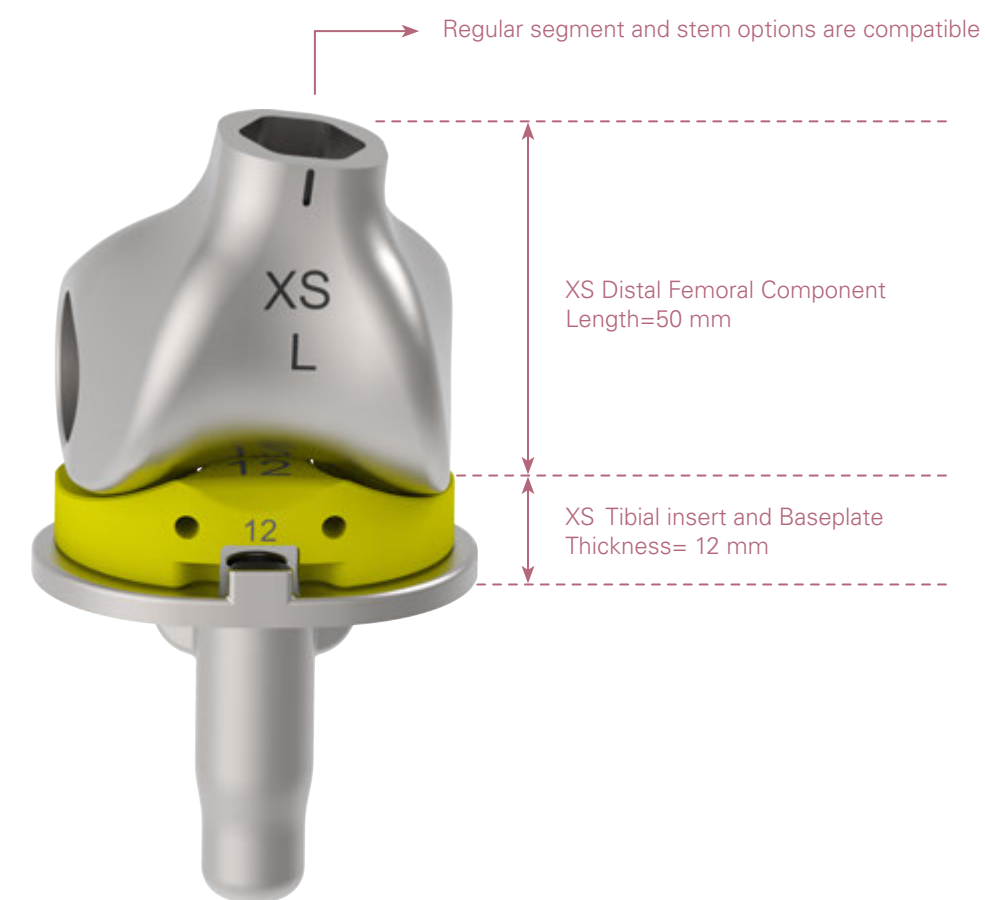

# Appendix II :

## Establish Tibial Platform for XS Baseplate

Set the knee in flexion to fully expose the tibial plateau. Use the **Step Drill** to find the canal. The entry location shall be approximately 10 mm posterior to the origin of anterior cruciate ligament.

Using the **T-Handle XS**, advance the **IM Rod XS** into the canal. Then remove the **T-Handle**.

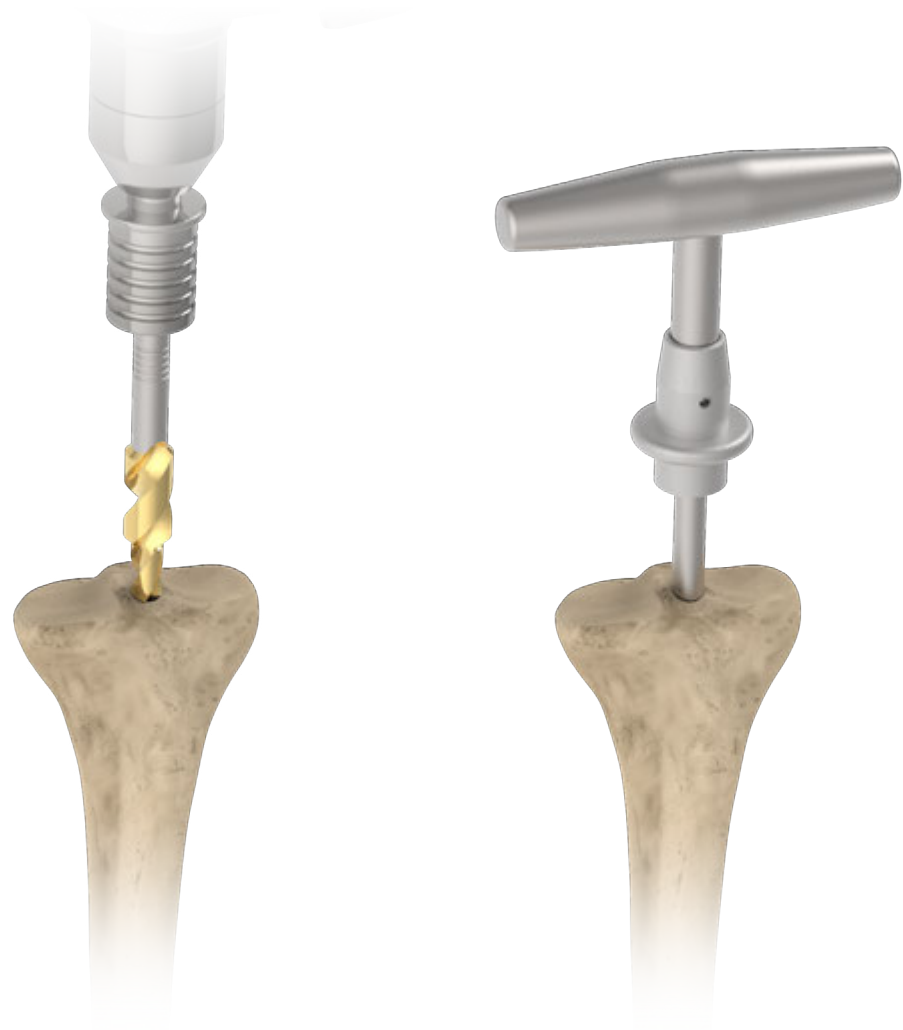

Instruments



Step Drill

T-Handle XS

IM-Rod XS

# Appendix II :

## Establish Tibial Platform for XS Baseplate

Assemble the **Tibial IM Alignment Guide XS** and the **Tibial Resection Guide XS** onto the **IM Rod XS**.

Insert the **Tibial Stylus** into the slot of the **Tibia Resection Guide XS**. Position the tip of the **Tibial Stylus** on the appropriate location on the tibial plateau. The **Resection Check Blade** may be used to confirm positioning.

Secure the **Tibial Resection Guide XS** with **Round Pins**. Remove the intramedullary assembly, leaving the resection guide in place. If needed, additional **Threaded Pins** may be used to further secure the resection guide.

Perform the proximal tibial resection using a standard .050" (1.27 mm) narrow saw blade inserted through the resection slot.

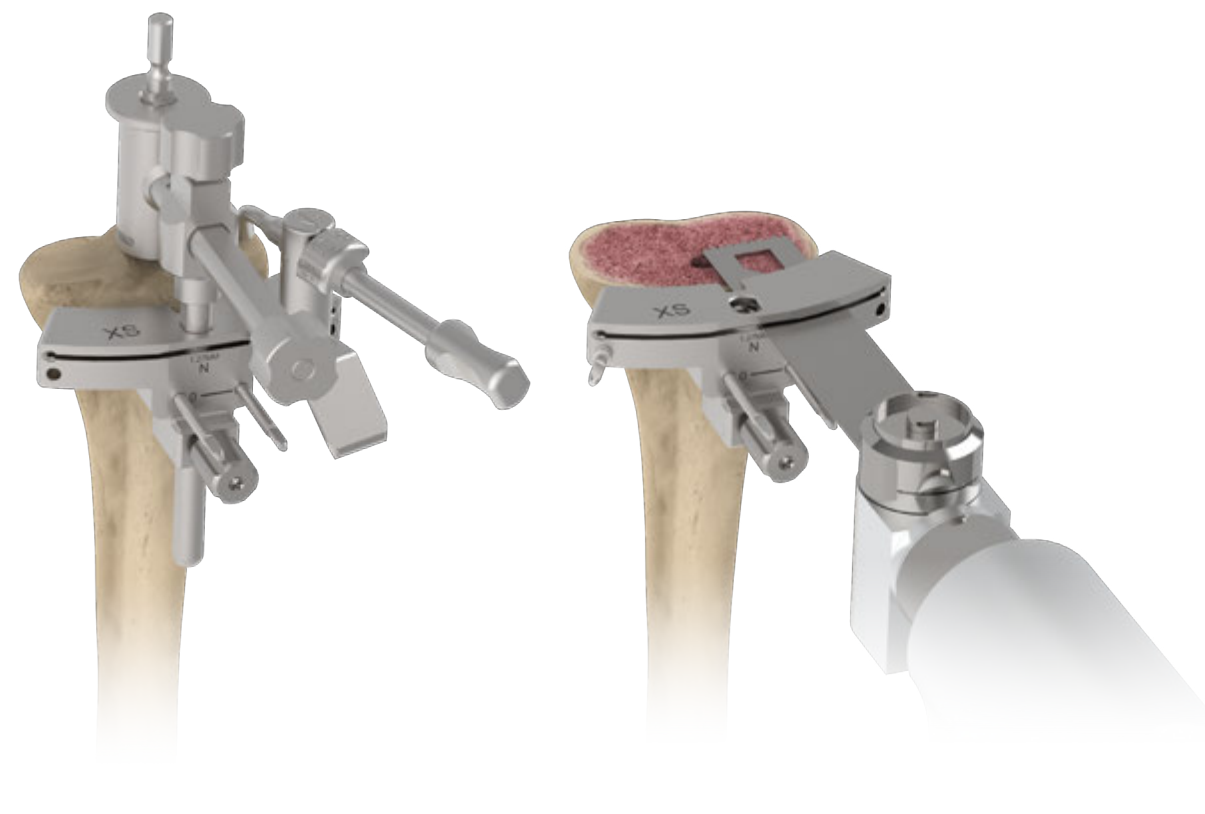

Instruments

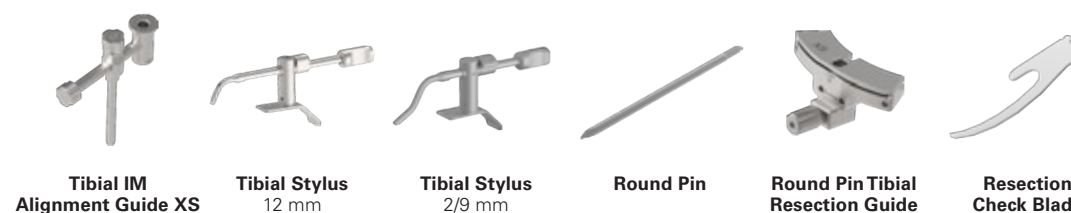

Tibial IM Alignment Guide XS

Tibial Stylus 12 mm

Tibial Stylus 2/9 mm

Round Pin

Round Pin Tibial Resection Guide

Resection Check Blade

# Appendix II :

## Finish Tibial Preparation for XS Baseplate

Attach the **Tibial Sizing Template XS** to the **Tibial Sizing Template Handle** and place onto the resected tibial surface.

Align the **Tibial Sizing Template XS** with the desired rotational position on the resected tibial surface, and secure with two **Round Pins**.

Attach the **Tibial Punch Guide XS** onto the sizing template.

Select the **Tibial Boss Drill XS** and advance through **Tibial Punch Guide XS** until fully engaged.

Continue with the regular trialing and implantation with the corresponding XS components as outlined in previous sections of this surgical technique guide.

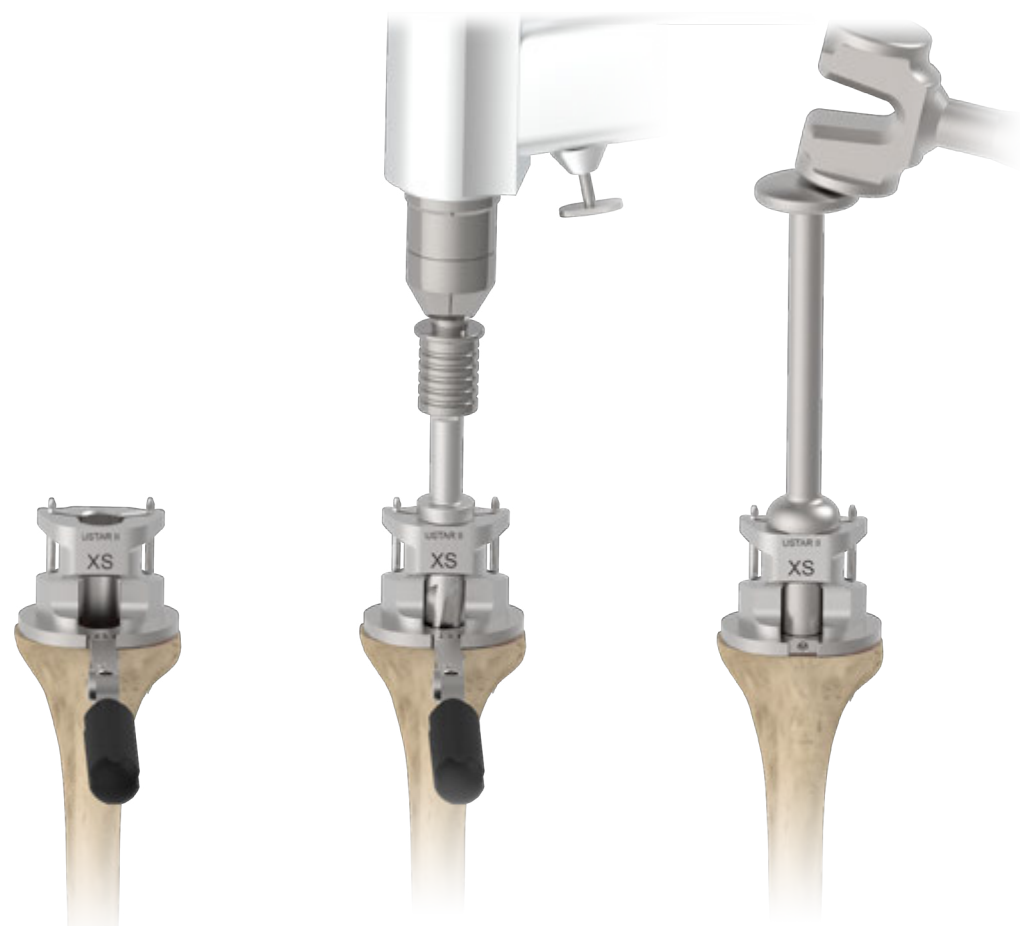

Instruments

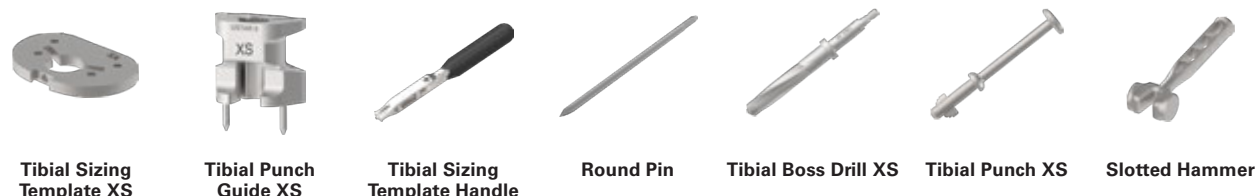

Tibial Sizing Template XS Tibial Punch Guide XS Tibial Sizing Template Handle Round Pin Tibial Boss Drill XS Tibial Punch XS Slotted Hammer

# Appendix II :

## Implantation

With the knee in flexion, place the selected tibial insert onto the implanted tibial baseplate assembly, making sure to maintain alignment with the hinge post of the distal femoral component.

With the knee in full extension, secure the tibial insert to the femoral prosthesis by tightening the built-in set screw inside the tibial insert with **Insert Set Screwdriver** to apply appropriate fixation torque.

Tighten the set screw until fully connected within the distal femoral component, confirming with the depth mark on the screwdriver.

Align the **depth mark S** on the screwdriver for the **size #XS** tibial insert.

If the depth mark is achieved but the torque limiter has not engaged, continue apply torque until engaged;

If the torque limiter is engaged before the depth mark is achieved, then the screw may not be correctly connected to the femoral component. Confirm the femoral assembly is fully seated in the tibial insert, then re-tighten the set screw.

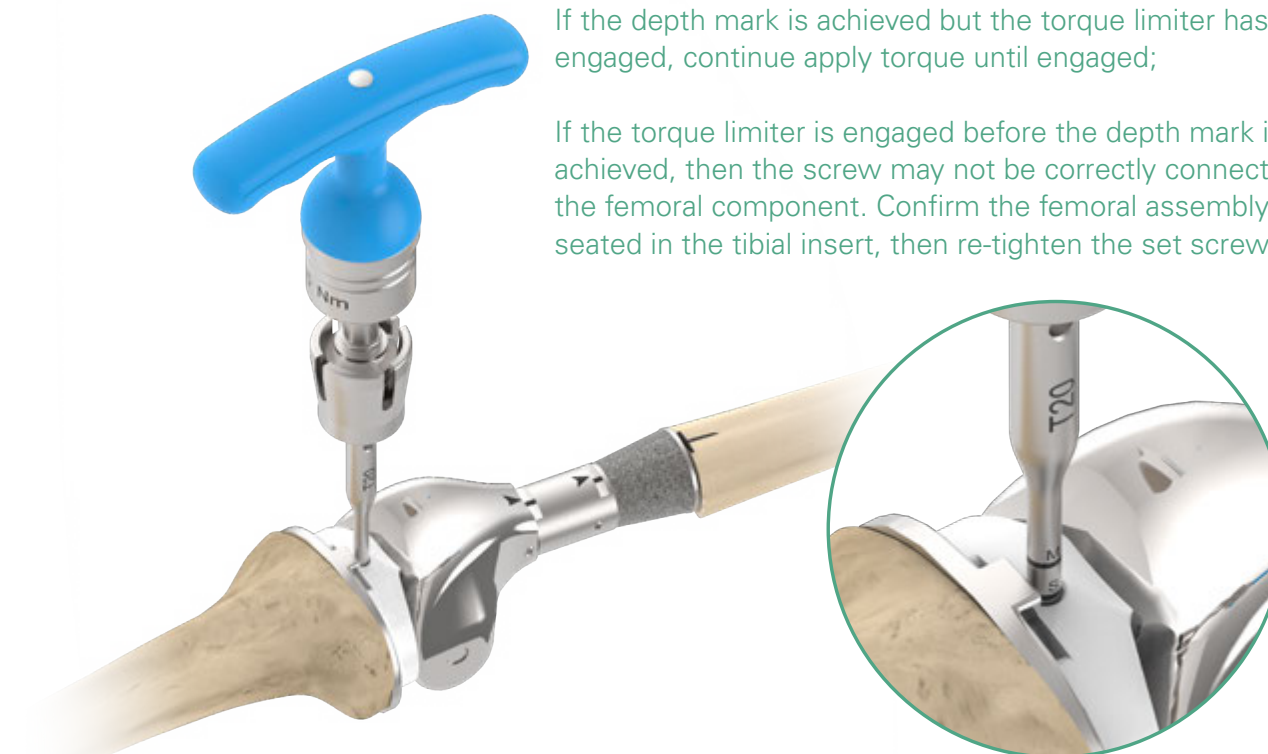

Instruments



Insert Set Screwdriver



# Appendix III. Proximal Tibial Assembly XS



Femoral Component XS

Built-in Stem Length : 85 mm from Distal Resection  
No Extension Stem nor Augment Options



Tibial Insert XS

Thickness : 12 mm



Proximal Tibial Component XS

Length : 73 mm  
(With XS Insert)



Segment

Length : 25 / 30 to 220 mm in 10 mm Increments

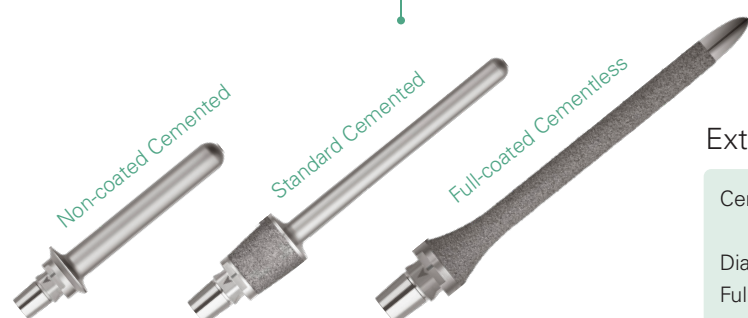

Extension Stem

Cemented Stem Length : Straight 100 / 125 mm  
Curved 125 / 150 mm  
Diameter : 9 / 11 / 13 / 15 / 17 mm  
Full-coated Stem Length : 150 / 200 mm  
Diameter : 11 / 13 / 15 / 17 mm

# Appendix III :

The overall length for size XS proximal tibial components and XS tibial insert is 73 mm, 8 mm less than standard resection. XS tibial component accept regular segment and stem options.

The distal/posterior femoral resection are 7 mm. No extension stem and augment are allowed.



Instruments



Femoral Component Trial, XS



Tibial Insert Trial, XS



Proximal Tibial Component Trial, XS

# Appendix III :

## Distal Femoral Resection for XS Femoral Component

Use the **Step Drill** to create an opening into the femoral canal. The drill is inserted to a depth of approximately 100 mm into the femoral canal. This allows for depressurization of the canal when the **IM Rod XS** is inserted.

Using the **T-Handle XS**, advance the **IM Rod XS** into the canal. Then remove the **T-Handle**.

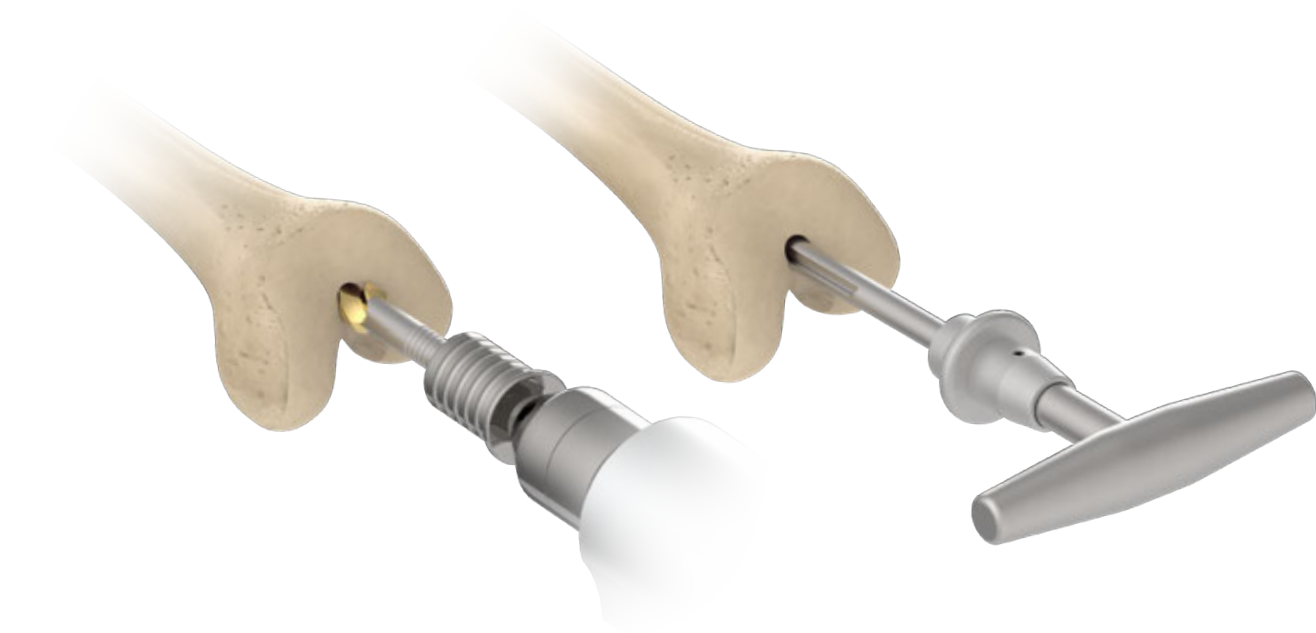

Instruments



Step Drill T-Handle XS IM-Rod XS

# Appendix III:

## Distal Femoral Resection for XS Femoral Component

Slide the **Femoral IM Alignment Guide XS** through the **IM Rod XS** until set against the femur. The alignment guide offers a fixed 6 degrees valgus angle.

Attach the **Distal Femoral Alignment Guide XS** and the **Distal Femoral Resection Guide XS** to the **Femoral IM Alignment Guide XS**.

Secure the **Distal Femoral Resection Guide XS** with **Round Pins**. Additional **Threaded Pins** may be placed to further secure the resection guide.

Remove the alignment guide assembly, and perform distal femoral resection.

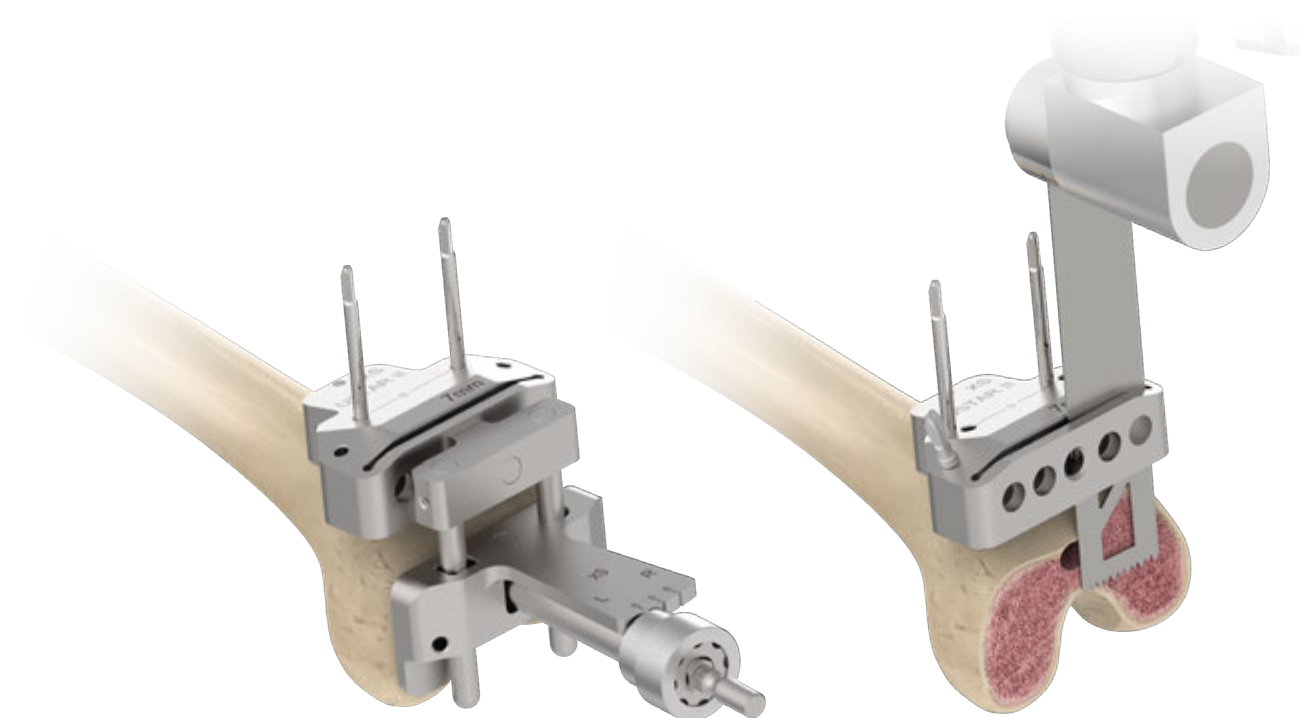

Instruments

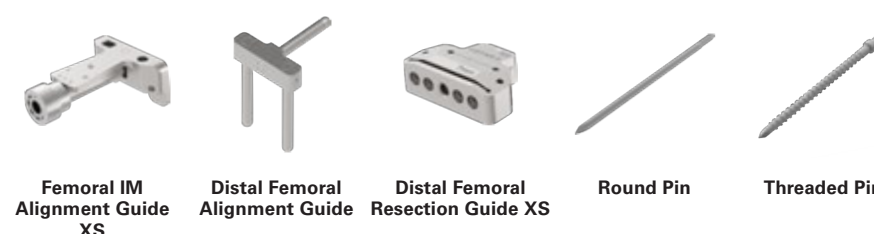

Femoral IM Alignment Guide XS Distal Femoral Alignment Guide Distal Femoral Resection Guide XS Round Pin Threaded Pin

# Appendix III :

## A/P and Chamfer resection for XS Femoral Component

Re-position the **IM Rod XS** into the canal.

Set the 3 degree external rotation to the correct "R" or "L" on the **Femoral Sizer XS** and position it onto the resected distal femur surface, through the **IM Rod XS**, and with the posterior condyles seated on the posterior feet of the sizer.

Make a pair of pilot holes through the pin holes on the sizer to align the **A/P and Chamfer Cutting Guide XS**. Remove the sizer assembly.

Place the **Femoral A/P Chamfer Cutting Guide** into the pre-drilled pin holes. Secure the cutting guide with **Threaded Pins** and complete the A/P and chamfer bone cut

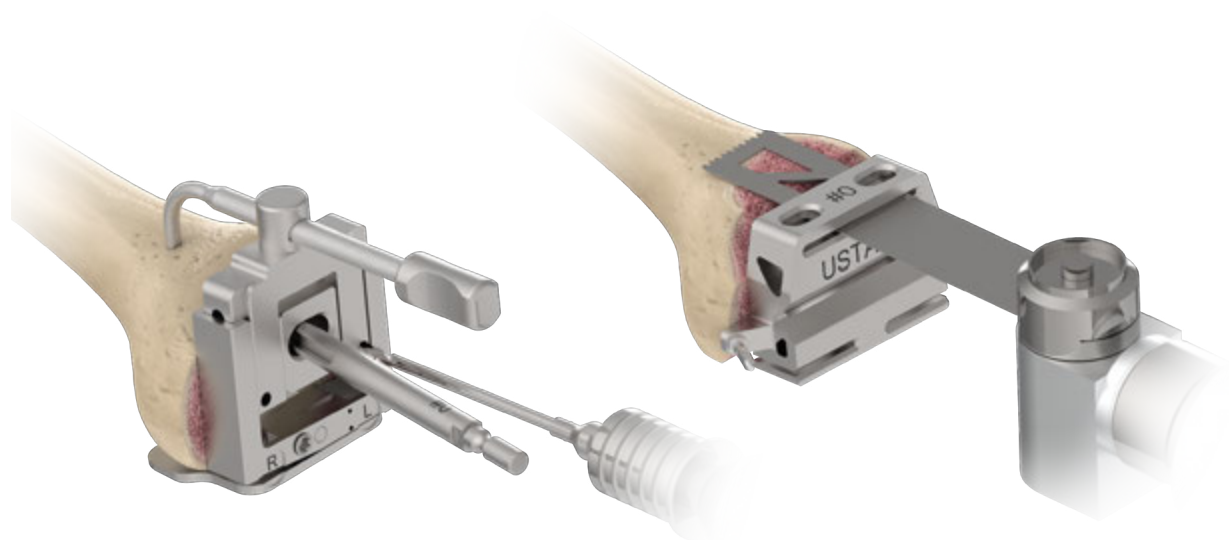

Instruments

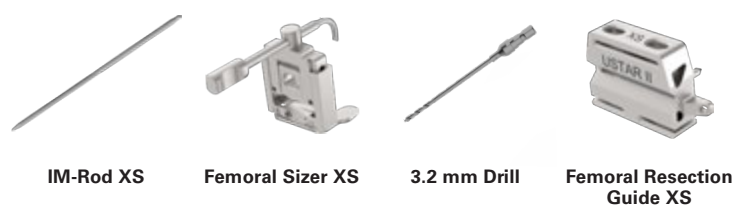

# Appendix III:

## Femoral Canal Preparation for XS Femoral Component

Position the **Femoral Sizing Template XS** onto the resected femur.

Assemble the **Femoral Drill Guide XS** onto the **Femoral Sizing Template XS** and secure with a **Threaded Pin**. Then drill with the **Femoral Stem Drill XS**.

Remove the **Femoral Drill Guide XS**.

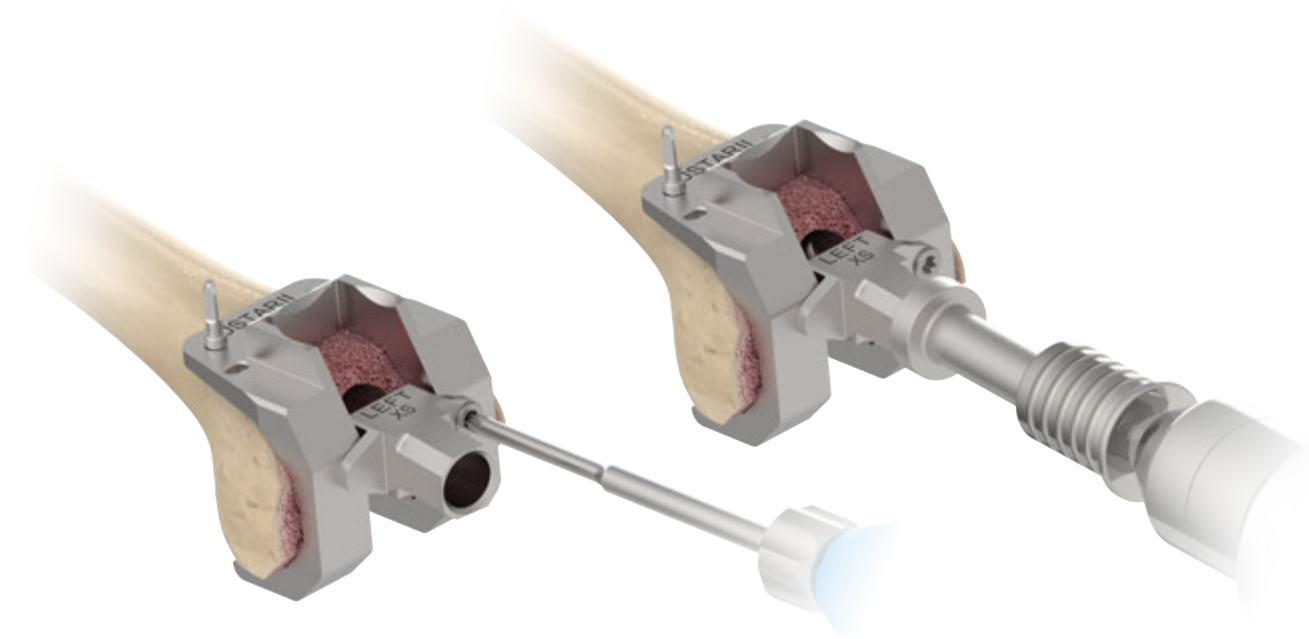

Instruments

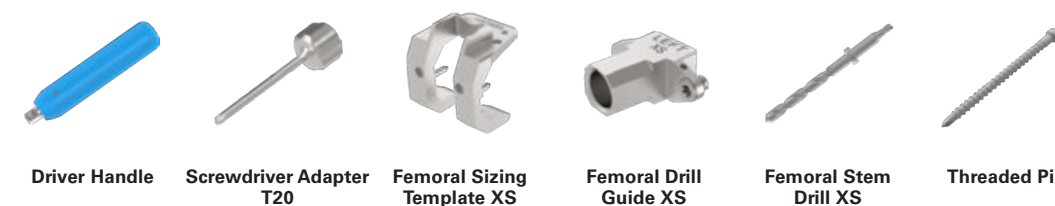

# Appendix III :

## Box Preparation for XS Femoral Component

Assemble the **Box Cutting Guide** to the **Femoral Sizing Template XS** with the **Screwdriver Adapter T20**.

Using a standard 1.27 mm saw blade, complete a parallel bone resection through the posterior cortex.

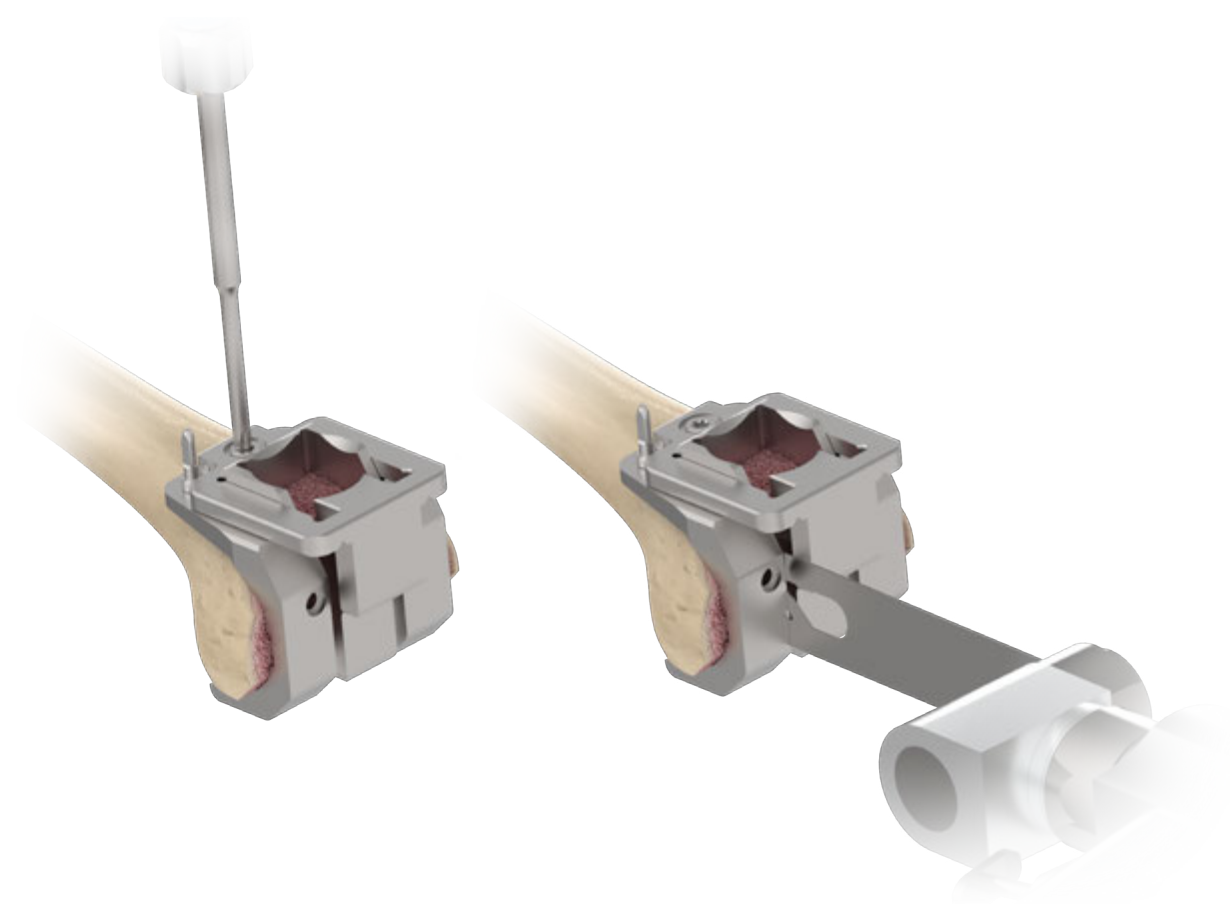

Instruments



# Appendix III:

## Box Preparation for XS Femoral Component

Using the **Box Reamer XS**, ream through **Box cutting guide** until the stop is fully engaged, in contact with the guide.

Impact the **Box Chisel XS** through the **Box Cutting Guide** to ensure the corners of the box housing are 'square'.

Continue with the regular trialing and implantation with the corresponding size of components as outlined in previous sections of this surgical technique guide.

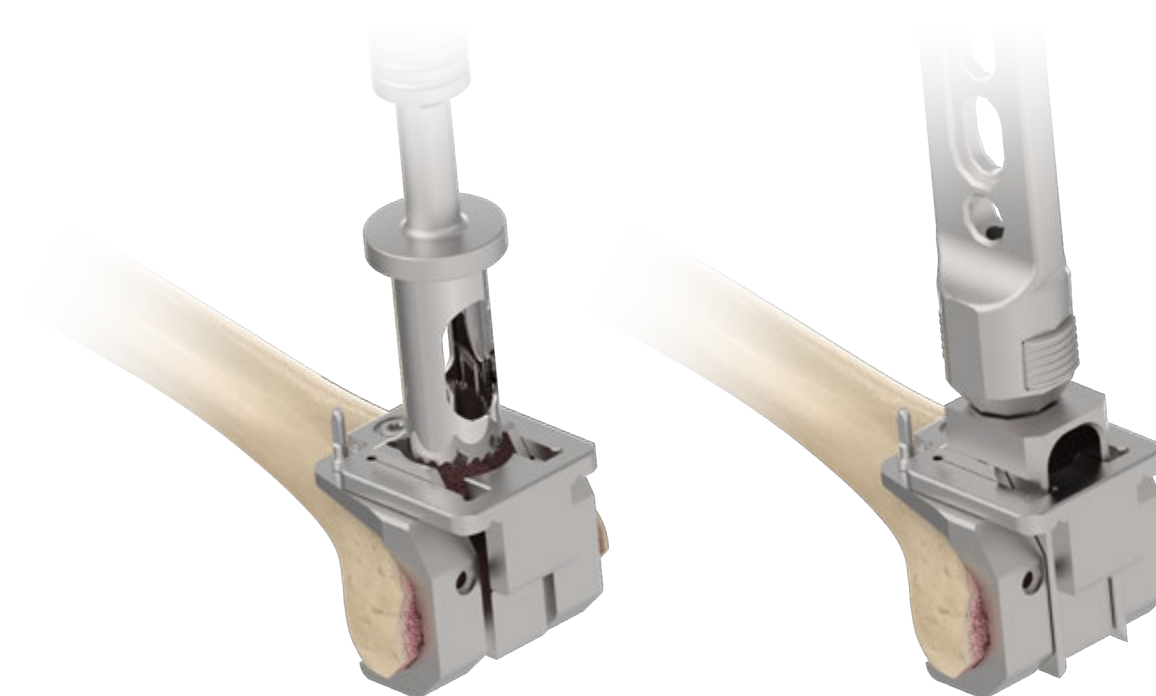

Instruments

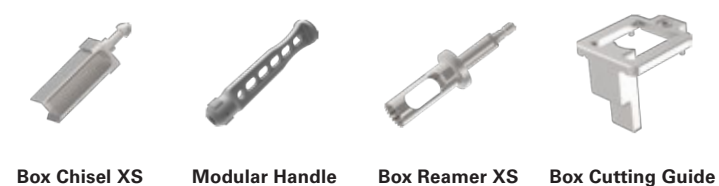

# Appendix III :

## Implantation

With the knee in flexion, place the selected tibial insert onto the implanted tibial construct assembly, making sure to maintain alignment with the hinge post of the femoral component.

With the knee in full extension, secure the tibial insert to the femoral prosthesis by tightening the built-in set screw inside the tibial insert with **Insert Set Screwdriver** to apply appropriate fixation torque.

Tighten the set screw until fully connected within the femoral component, confirming with the depth mark on the screwdriver.



Insert Set  
Screwdriver



# Order Information

## Proximal Femoral Component



Trochanteric	
Left	Right
1115-9110	1115-9210



Low Profile	
Left	Right
1115-9120	1115-9220

\* Low Profile type is not CE Marked

## Femoral Component



	Left	Right	AP X ML
#1	2115-1310	2115-1410	52 x 56
#2	2115-1320	2115-1420	56 x 60
#3	2115-1330	2115-1430	60 x 64
#4	2115-1340	2115-1440	64 x 68
#5	2115-1350	2115-1450	68 x 72
#6	2115-1360	2115-1460	72 x 76



**Femoral Screw**  
2903-1014

## Distal Femoral Component



	Left	Right	AP X ML
S	2115-3310	2115-3410	52 x 56

# Order Information

## XPE Tibial Insert



	12 mm	14 mm	17 mm	20 mm	23 mm	26 mm	30 mm
S	2315-3211	2315-3212	2315-3213	2315-3214	2315-3215	2315-3216	2315-3217
M	2315-3241	2315-3242	2315-3243	2315-3244	2315-3245	2315-3246	2315-3247

## Tibial Baseplate



	Cat. No.	AP X ML
#1	2215-1410	42 x 63
#2	2215-1420	45 x 66
#3	2215-1430	47 x 69
#4	2215-1440	50 x 72
#5	2215-1450	53 x 76
#6	2215-1460	56 x 80

## Proximal Tibial Component



	Cat. No.	AP X ML
S	2215-3410	42 x 63

# Order Information

## Segment Parts



25 mm	30 mm	40 mm	50 mm	60 mm	70 mm	80 mm
2915-1025	2915-1030	2915-1040	2915-1050	2915-1060	2915-1070	2915-1080
90 mm	100 mm	110 mm	120 mm	130 mm	140 mm	150 mm
2915-1090	2915-1100	2915-1110	2915-1120	2915-1130	2915-1140	2915-1150
160 mm	170 mm	180 mm	190 mm	200 mm	210 mm	220 mm
2915-1160	2915-1170	2915-1180	2915-1190	2915-1200	2915-1210	2915-1220

## Bridge Component



80 mm
2915-3080

# Order Information

## Cemented Stem



	Straight		Curved	
	100 mm	125 mm	125 mm	150 mm
Ø9	2715-1009	2715-1109	2515-1109	2515-1209
Ø11	2715-1011	2715-1111	2515-1111	2515-1211
Ø13	2715-1013	2715-1113	2515-1113	2515-1213
Ø15	2715-1015	2715-1115	2515-1115	2515-1215
Ø17	2715-1017	2715-1117	2515-1117	2515-1217

## Non-Coated Cemented Stem



	Straight		Curved	
	100 mm	125 mm	125 mm	150 mm
Ø9	2715-3009	2715-3109	2515-3109	2515-3209
Ø11	2715-3011	2715-3111	2515-3111	2515-3211
Ø13	2715-3013	2715-3113	2515-3113	2515-3213
Ø15	2715-3015	2715-3115	2515-3115	2515-3215
Ø17	2715-3017	2715-3117	2515-3117	2515-3217

## Full-Coated Cementless Stem



	Straight		Curved	
	150 mm	200 mm	150 mm	200 mm
Ø11	1115-3211	1115-3411	1115-1211	1115-1411
Ø13	1115-3213	1115-3413	1115-1213	1115-1413
Ø15	1115-3215	1115-3415	1115-1215	1115-1415
Ø17	1115-3217	1115-3417	1115-1217	1115-1417

# Order Information

## Femoral Component Accessories

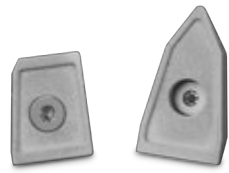

	Distal Femoral Augment					
	4 mm LM / RL	4 mm LL / RM	8 mm LM / RL	8 mm LL / RM	12 mm	16 mm
#1	2603-5111	2603-5211	2603-5112	2603-5212	2603-5313	2603-5314
#2	2603-5121	2603-5221	2603-5122	2603-5222	2603-5323	2603-5324
#3	2603-5131	2603-5231	2603-5132	2603-5232	2603-5333	2603-5334
#4	2603-5141	2603-5241	2603-5142	2603-5242	2603-5343	2603-5344
#5	2603-5151	2603-5251	2603-5152	2603-5252	2603-5353	2603-5354
#6	2603-5161	2603-5261	2603-5162	2603-5262	2603-5363	2603-5364



	Posterior Femoral Augment	
	4 mm	8 mm
#1	2603-5011	2603-5012
#2	2603-5021	2603-5022
#3	2603-5031	2603-5032
#4	2603-5041	2603-5042
#5	2603-5051	2603-5052
#6	2603-5061	2603-5062



Offset Adapter		
2 mm	4 mm	6 mm
2903-1010	2903-1020	2903-1030



	Straight Femoral Press-fit Stem				
	30 mm	75 mm	100 mm	150 mm	200 mm
Ø10	NA	2703-5011	2703-5021	2703-5051	2703-5061
Ø12	NA	2703-5012	2703-5022	2703-5052	2703-5062
Ø14	2703-5003	2703-5013	2703-5023	2703-5053	2703-5063
Ø16	NA	2703-5014	2703-5024	2703-5054	2703-5064
Ø18	NA	2703-5015	2703-5025	2703-5055	2703-5065
Ø20	NA	2703-5016	2703-5026	2703-5056	2703-5066
Ø22	NA	2703-5017	2703-5027	2703-5057	2703-5067
Ø24	NA	2703-5018	2703-5028	2703-5058	NA

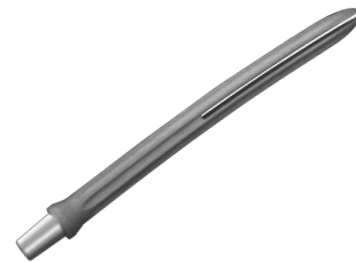

	Curved Femoral Press-fit Stem	
	150 mm	200 mm
Ø10	2703-5031	2703-5041
Ø12	2703-5032	2703-5042
Ø14	2703-5033	2703-5043
Ø16	2703-5034	2703-5044
Ø18	2703-5035	2703-5045
Ø20	2703-5036	2703-5046
Ø22	2703-5037	2703-5047
Ø24	2703-5038	NA

# Order Information

## Tibial Baseplate Accessories



	Tibial Augment			
	5 mm	10 mm	15 mm LM / RL	15 mm LL / RM
#1	2815-1011	2815-1012	2815-1113	2815-1213
#2	2815-1021	2815-1022	2815-1123	2815-1223
#3	2815-1031	2815-1032	2815-1133	2815-1233
#4	2815-1041	2815-1042	2815-1143	2815-1243
#5	2815-1051	2815-1052	2815-1153	2815-1253
#6	2815-1061	2815-1062	2815-1163	2815-1263



	Cemented Tibial Stem			
	20 mm	45 mm	70 mm	95 mm
Ø9	2715-5109	2715-5209	2715-5309	2715-5409



	Press-Fit Tibial Stem			
	45 mm	70 mm	95 mm	120 mm
Ø12.5	2715-7212	2715-7312	2715-7412	2715-7512
Ø14	2715-7214	2715-7314	2715-7414	2715-7514



Cat. No.	Size	Canal size (mm)
1907-1008	#8	8-9
1907-1010	#10	10-11
1907-1012	#12	12-13
1907-1014	#14	14-15
1907-1016	#16	16-17
1907-1018	#18	18-19

# Order Information

## Biolox® *delta* Ceramic Head



	-3 mm	-2.5 mm	+1 mm	+4 mm	+5 mm	+8 mm	+9 mm
Ø28	NA	1203-5028	1203-5228	1203-5428	NA	NA	NA
Ø32	1203-5032	NA	1203-5232	NA	1203-5432	1203-5632	NA
Ø36	1203-5036	NA	1203-5236	NA	1203-5436	NA	1203-5636
Ø40	1203-1036	NA	1203-1136	NA	1203-1236	NA	1203-1436

\*BIOLOX® OPTION is the registry trademark of Ceramtec.

## U2 Femoral Head



	-3 mm	-2 mm	+0 mm	+2.5 mm	+3 mm	+5 mm	+6 mm	+7.5 mm	+9 mm	+10 mm
Ø22	NA	NA	1206-1122	NA	1206-1322	NA	1206-1522	NA	1206-1722	NA
Ø26	NA	1206-1026	1206-1126	NA	1206-1326	NA	1206-1526	NA	1206-1726	NA
Ø28	1206-1028	NA	1206-1128	1206-1228	NA	1206-1428	NA	1206-1628	NA	1206-1828
Ø32	1206-1032	NA	1206-1132	1206-1232	NA	1206-1432	NA	1206-1632	NA	1206-1832
Ø36	1206-1036	NA	1206-1136	1206-1236	NA	1206-1436	NA	1206-1636	NA	1206-1836

## Trochanteric Claw



Size	Cat. No.
Small	1915-1010
Large	1915-1020

\* Trochanteric Claws are not CE Marked

# Size #XS Implants

## Femoral Component



Left	Right	AP X ML
2115-1300	2115-1400	45 x 50

## Distal Femoral Component



Left	Right	AP X ML
2115-3300	2115-3400	45 x 50

## XPE Tibial Insert



12 mm
2315-3201

## Proximal Tibial Component



Cat. No.	AP X ML
2215-3400	38 x 58

## Tibial Baseplate



Cat. No.	AP X ML
2215-1400	38 x 58

Please note that this Surgical Technique Guide has been authored in the English language. Any translations into other languages have not been reviewed or approved by United Orthopedic Corporation and their accuracy cannot be confirmed. Any translated guide should be reviewed carefully prior to use and questions regarding a Surgical Technique Guide should be directed to United Orthopedic Corporation at [unitedorthopedic.com/contact/](http://unitedorthopedic.com/contact/)

The CE mark is valid only if it is also printed on the product label.

